

MONTERINGSANVISNING

Kantlister – Produktgruppe 9030

1 Leverandør

Fritzøe Engros AS
Postboks 2055

Telefon: + 47 33 13 64 00

E-post: teknisk@fritzoengros.no
Web: www.fritzoengros.no

2 Produktnavn

Kantlister i forskjellige dekor.

3 Produktbeskrivelse

ABS kantlister er produsert av ABS som er et miljøvennlig plastprodukt. Erstatte tidligere PVC. Lagerføres i utvalgte dekor som matcher laminat og melaminbelagte plater. Leveres i tykkelse fra 0,8 mm til 2 mm, og i bredder fra 19 mm til 104 mm.

5 Lagring og klimatisering

Kontroll:

Kantlistene skal kontrolleres for eventuelle synlige feil- og skader før montering. Reklamasjoner skal med en gang meldes til forhandler før montering. Les hele monteringsanvisningen før monteringen starter.

Produktinformasjon:

ABS kantlister er produsert av et miljøvennlig plastprodukt som kalles ABS. Det er et oljebasert produkt, se for øvrig annen dokumentasjon på vår hjemmeside. De aller fleste ABS kantlistene vi lagerfører, er uten lim. Påføres best med egnet kantlist-maskin og smelte-lim. Kan limes manuelt med kontaktlim eller annen egnet monteringslim.

Oppbevaring:

Lagres tørt og liggende, helst i kartongen de kom i. Beskytt kantlistene mot sollys og sterk varme.

6 Montering

ABS kantlister påføres platen etter anvisning fra den enkelte maskinleverandør. Ved liming med kontaktlim eller annen egnet monteringslim er det viktig at kantlisten stikker litt ut over- og under kanten på platene den limes på.

Etter at limet er ferdig herdet, fjernes/avrundes kantlisten med en kantlist høvel eller forsiktig med en skarp kniv, for så å pusse lett over med et fint sandpapir.

7 HMS

Det er ikke behov for spesielle forebyggende tiltak ved håndtering eller bearbeiding av ABS kantlister. Det anbefales bruk av personlig verneutstyr, som støvmaske, hørselvern og vernebriller, når ABS kantlister bearbeides.

MONTERINGSANVISNING

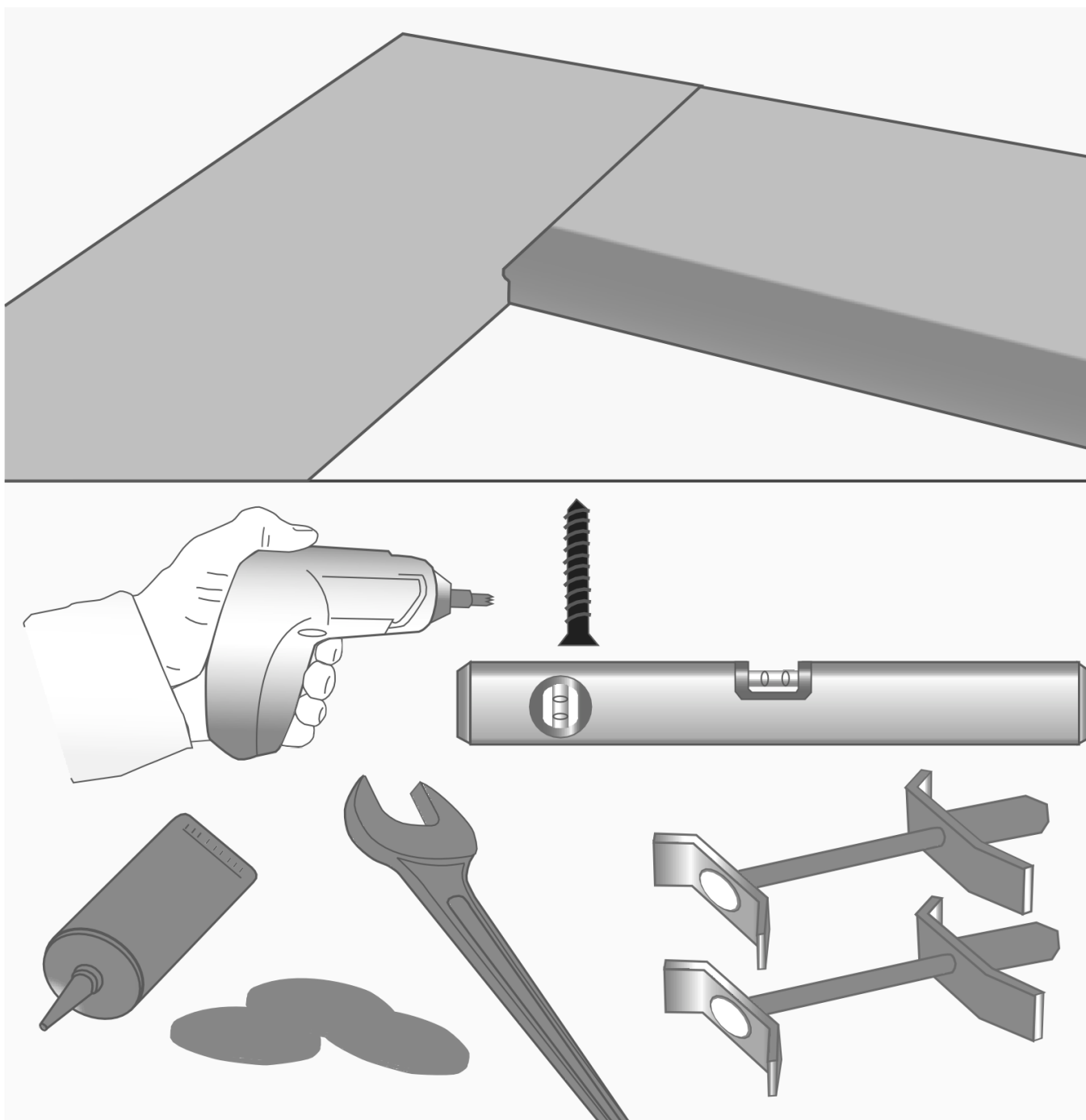

MONTERINGSANVISNING

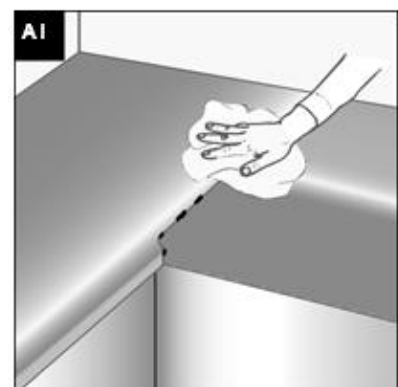
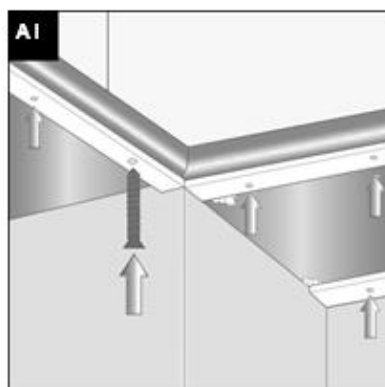
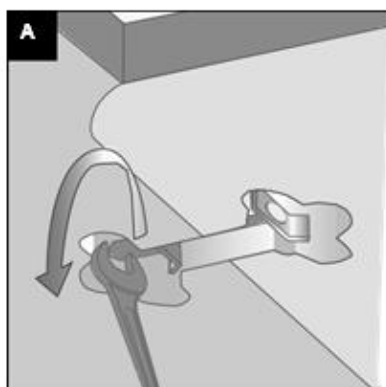
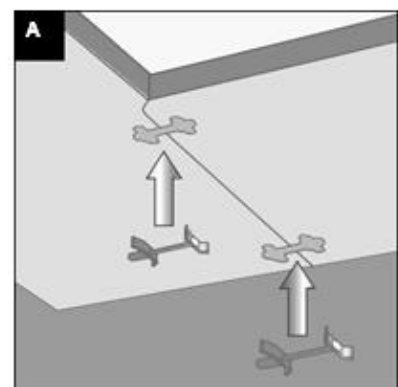
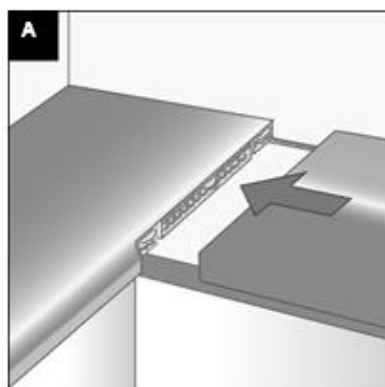
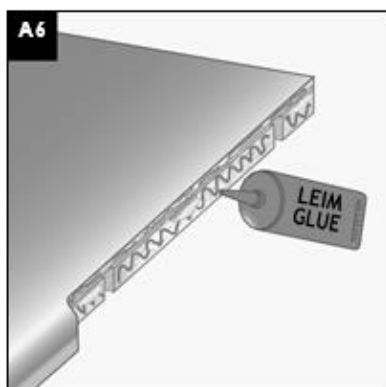
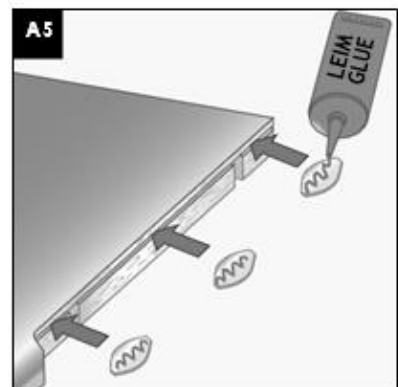
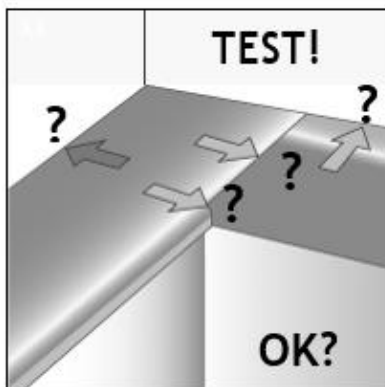
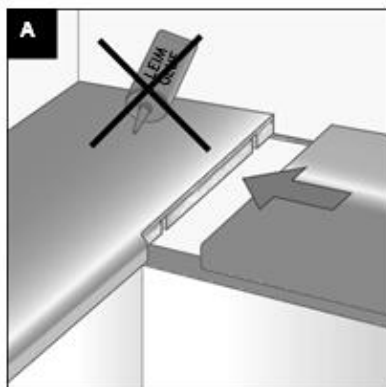
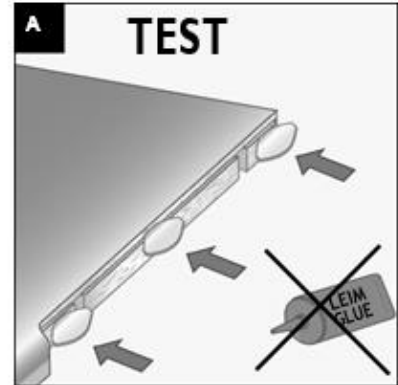
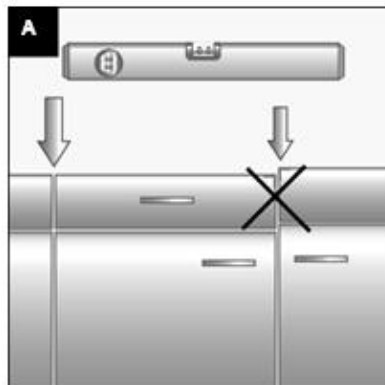
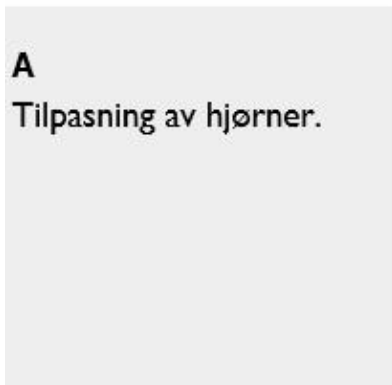

MONTERINGSANVISNING

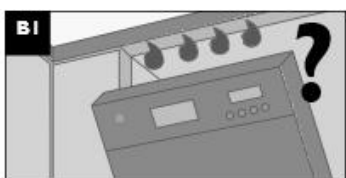
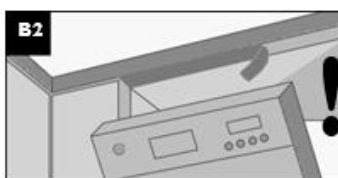
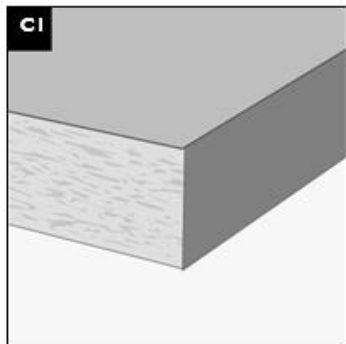
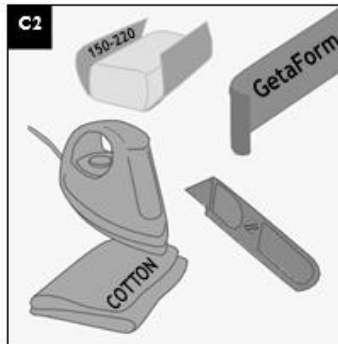
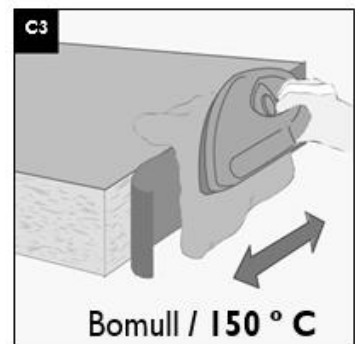
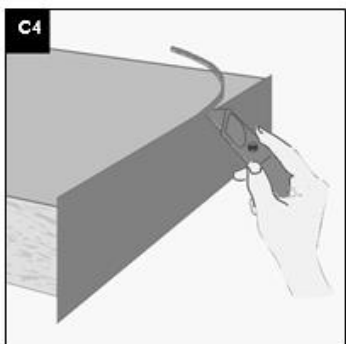
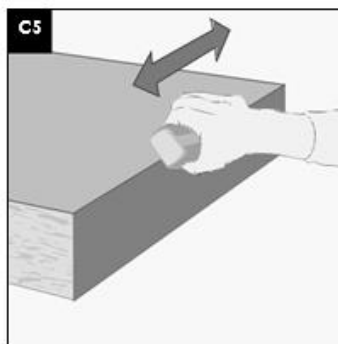
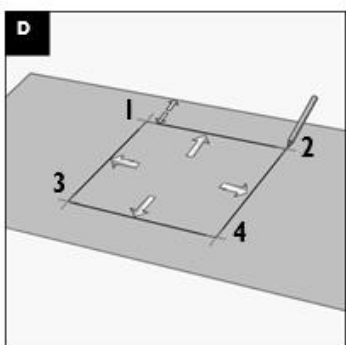
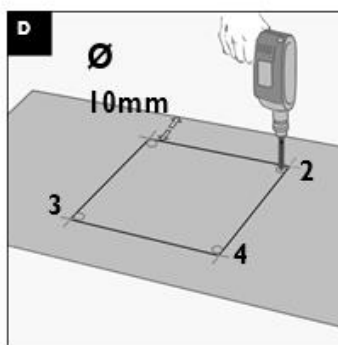
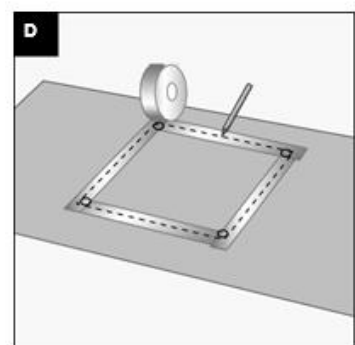
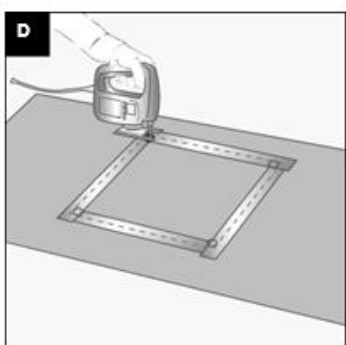
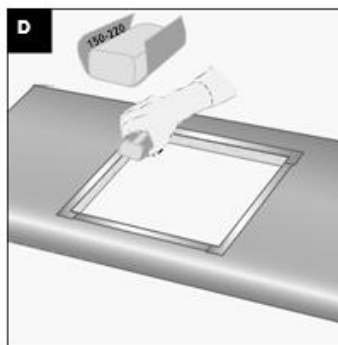
B Aluminiumstape	B1 	B2 
C Kantlister.	C1 	C2 
C3  Bomull / 150 ° C	C4 	C5 
D Utskjering for vask.	D 	D Ø 10mm 
D 	D 	D 150-220 

MONTERINGSANVISNING

