

MEG

MATERIAL EXTERIOR GRADE

BUILDING
FAÇADES

TECHNICAL
MANUAL

ABET LAMINATI



Unlimited selection

TABLE OF CONTENTS



MATERIAL EXTERIOR GRADE

| | |
|--|-----------|
| 1. Product description | 2 |
| 2. Advantages of MEG | 2 |
| 3. Product properties | 2 |
| 3.1. Ageing and weathering resistance | 2 |
| 3.2. Dimensional stability | 2 |
| 3.3. Cleaning | 2 |
| 3.4. Removing graffiti | 3 |
| 3.5. Physical and mechanical characteristics | 3 |
| 3.6. Reaction to fire | 4 |
| 3.7. Certificates | 4 |
| 3.7.1. CE marking | 4 |
| 3.7.2. Certifications | 4 |
| 3.8. Environment | 4 |
| 3.9. Warranty | 4 |
| 4. Transport and storage | 5 |
| 4.1. Transport | 5 |
| 4.2. Storage | 5 |
| 5. Processing the panels | 6 |
| 5.1. Acclimatisation | 6 |
| 5.2. Processing conditions | 7 |
| 5.3. Safety instructions | 8 |
| 5.4. Sawing | 8 |
| 5.4.1. Types of saw | 8 |
| 5.4.2. Saw blade | 8 |
| 5.4.3. Cutting | 9 |
| 5.5. Milling cutters | 9 |
| 5.5.1. Milling machines | 9 |
| 5.5.2. Types of milling cutter | 9 |
| 5.5.3. Milling | 10 |
| 5.6. Drills | 10 |
| 6. Façade application | 10 |
| 6.1. Principle of a ventilated façade | 10 |
| 6.2. Joints | 12 |
| 6.3. Corner solutions | 14 |
| 6.4. Fixing plan | 15 |
| 6.5. Fixing systems | 16 |
| 6.5.1. General guidelines | 16 |
| 6.5.2. Types of structure | 16 |
| 6.5.2.1. Vertical wooden battening with wooden substructure | 16 |
| 6.5.2.2. Vertical wooden battening with double wooden substructure | 17 |
| 6.5.2.3. Vertical wooden battening with aluminium or galvanised steel anchoring | 17 |
| 6.5.2.4. Vertical wooden battening with distance anchoring | 18 |
| 6.5.2.5. Vertical aluminium Omega and Z profiles with distance anchoring | 18 |
| 6.5.2.6. Vertical aluminium profile with aluminium anchoring | 19 |
| 6.5.3. Types of fixing | 19 |
| 6.5.3.1. Visible mechanical fixing | 19 |
| 6.5.3.1.1. General principles | 19 |
| 6.5.3.1.2. Visible mechanical fixing on a wooden backing structure | 20 |
| 6.5.3.1.3. Visible mechanical fixing on an aluminium backing structure | 23 |
| 6.5.3.2. Gluing on wooden substructure | 26 |
| 6.5.3.3. Gluing on aluminium substructure | 29 |
| 6.5.3.4. Invisible fixing with overlapping panel strips (weatherboarding or lap siding) | 32 |
| 6.5.3.5. Invisible fixing with profiled edged panels in horizontal running aluminium hook profile | 35 |
| 6.5.3.6. Invisible fixing with panel hooks (anchors) on aluminium horizontal running hook profile with aluminium subconstruction | 38 |
| 6.5.3.7. Sandwich panel in profile system | 42 |
| 6.5.4. Special fixings | 42 |
| 6.5.4.1. Canopy cladding | 42 |
| 6.5.4.2. Curved cladding | 42 |
| 6.5.4.3. Perforated cladding | 43 |
| 6.5.4.4. Shutters | 44 |
| 6.5.4.5. Sun screens | 44 |
| 7. Parapets and balustrades | 45 |
| 7.1. General guidelines | 45 |
| 7.2. Fixing principles | 45 |
| 7.2.1. Types of fixing | 45 |
| 7.2.2. Balcony separations | 47 |
| 8. Maintenance | 48 |
| 9. Disclaimer | 48 |



MATERIAL EXTERIOR GRADE

1. Product description

MEG is a self-supporting laminate panel manufactured under high pressure (HPL - High Pressure Laminate) with a decorative surface suitable for outdoor applications, resistant to light and weathering, complying with EN 438:2005, part 6. The core of the panel consists of layers of saturated kraft paper impregnated with phenolic resin and at least one decorative layer of cellulose paper impregnated with thermosetting resin, having both aesthetic and weather resistant functions. In the production process, heat (at 150°C) and high pressure (9 MPa) are combined in special multi-daylight presses in which the polycondensation of the resins occurs. One or both sides can have a decorative surface. The panels are available in standard version (MEG) and flame retardant version (MEG F1), which have improved reaction to fire.

2. Advantages of MEG

- Resists weathering and sunlight
- Mechanically robust
- Non-splintering
- Does not corrode and is not corrosive
- Easily workable
- Optimum fire behaviour
- Resistant to termites
- Antistatic
- Easily cleaned
- Aesthetically pleasing
- Environmentally-friendly
- Available in a wide variety of colours and decorative finishes

MEG is a durable material, available in a wide colour range, with high technical performance, especially suitable for the construction industry where it is an excellent alternative to traditional materials.

MEG is used for façade cladding, parapets and balustrades, and signage, and is particularly suited for building ventilated façades.

3. Product properties

3.1. Ageing and weathering resistance

By nature, MEG can be permanently exposed to the combined effects of sunlight and weather such as rain, hail, wind and salt air.

The influence of exhaust gas or acid rain on MEG is insignificant.

The decorative layer does not flake or delaminate.

It is resistant to extreme temperature fluctuations and retains its physical and mechanical properties. Such extreme fluctuations as from -30°C to +70°C and from extreme aridity to a relative humidity of 90% have no effect on the appearance and properties of the panels.

3.2. Dimensional stability

Under the influence of natural phenomena, MEG will undergo a limited change in its dimensions: the material shrinks at low humidity levels and expands at high humidity levels.

Allowing the material to acclimatise in the place of use is therefore recommended. If this is not possible or where the climate is characterised by extreme fluctuations (cold-hot or dry-wet), certain precautions must be taken in the design stage and during installation; for advice please contact your nearest Abet Laminati branch.

The special compactness of MEG ensures an ideal combination of mechanical characteristics such as flexural and tensile strength and impact resistance.

The panels' homogeneity and high density ensure excellent tensile strength for such fixing elements as screws or inserts.

3.3. Cleaning

The surface of MEG requires no special treatment for cleaning purposes.

Any dirt left behind from sawing or assembly can be removed with ordinary, non-abrasive organic solvent free household cleaners using paper, sponge and soft cloths. It is advisable to rinse off thoroughly and completely remove any detergent remaining. Then the panel must be dried properly to avoid leaving marks. Normal air pollution deposits on the installed panels can be removed with ordinary, non-abrasive household cleaners. Avoid excessive rubbing or pressure or using aids that could cause abrasion marks or scratches.

3.4. Removing graffiti

MEG's chemical resistant nature and closed structure do not allow paint in spray cans, various inks, emulsion paints, lipstick or pastel paints to penetrate into the decorative layer therefore MEG does not require any anti-graffiti treatment.
If the surface of the MEG is coated with graffiti or for more details about removing it, please contact your nearest Abet Laminati branch.



MATERIAL EXTERIOR GRADE

3.5. Physical and mechanical characteristics

| Property | Test method | Measured criterion | Unit | Required values EN 438 | | Typical values MEG | |
|--|--------------|-------------------------------|-------------------------|--|-------|--|-------|
| Thickness | EN 438-2.5 | Tolerance | mm | 2.0≤t<3.0 | ±0.20 | 2.0≤t<3.0 | ±0.20 |
| | | | | 3.0≤t<5.0 | ±0.30 | 3.0≤t<5.0 | ±0.30 |
| | | | | 5.0≤t<8.0 | ±0.40 | 5.0≤t<8.0 | ±0.40 |
| | | | | 8.0≤t<12.0 | ±0.50 | 8.0≤t<12.0 | ±0.50 |
| | | | | 12.0≤t<16.0 | ±0.60 | 12.0≤t<16.0 | ±0.60 |
| | | | | 16.0≤t<20.0 | ±0.70 | 16.0≤t<20.0 | ±0.70 |
| Flatness* | EN438-2.9 | Maximum deviation | mm/m | 1 side decor | | 1 side decor | |
| | | | | 2.0≤t<5.0 | ≤50 | 2.0≤t<5.0 | ≤50 |
| | | | | 2 side decor | | 2 side decor | |
| | | | | 2.0≤t<6.0 | ≤8.0 | 2.0≤t<6.0 | ≤8.0 |
| | | | | 6.0≤t<10.0 | ≤5.0 | 6.0≤t<10.0 | ≤5.0 |
| | | | | t≥10.0 | ≤3.0 | t≥10.0 | ≤3.0 |
| Length and width | EN 438-2.6 | Tolerance | mm | +10/0 | | +10/0 | |
| Straightness of edges | EN 438-2.7 | Maximum deviation | mm/m | 1.5 | | 1.5 | |
| Squariness | EN 438-2.8 | Maximum deviation | mm/m | 1.5 | | 1.5 | |
| Resistance to wet conditions | EN 438-2.15 | Mass increase | % (max) | EDS | | EDS / EDF | |
| | | | | 2.0≤t<5.0 | ≤7.0 | t≥2.0 | 3 |
| | | | | t≥5.0 | ≤5.0 | | |
| | | | | EDF | | | |
| | | 2.0≤t<5.0 | ≤10.0 | | | | |
| | | t≥5.0 | ≤8.0 | | | | |
| | | Appearance | Rating (min) | ≥4 | | ≥4 | |
| Dimensional stability at elevated temperatures | EN 438-2.17 | Variation | % length | 2.0≤t<5.0 | ≤0.4 | 2.0≤t<5.0 | ≤0.4 |
| | | | % width | | ≤0.8 | | ≤0.8 |
| | | | % length | t≥5.0 | ≤0.3 | t≥5.0 | ≤0.15 |
| | | | % width | | ≤0.6 | | ≤0.3 |
| Resistance to impact by large diameter ball (shatter resistance) | EN 438-2.21 | Drop height | mm (min) | 2.0≤t<6.0 | 1400 | 2.0≤t<6.0 | 1400 |
| | | | | t≥6.0 | 1800 | t≥6.0 | 1800 |
| | | Indentation diameter | mm (max) | 10 | | 6 | |
| Resistance to climate shock | EN 438-2.19 | Appearance | Rating (min) | ≥4 | | ≥4 | |
| | | Flexural strength index (Ds) | min | ≥0.95 | | ≥0.95 | |
| | | Elasticity modulus index (Dm) | min | ≥0.95 | | ≥0.95 | |
| Resistance to UV light** | EN 438-2.28 | Contrast | Grey Scale Rating (min) | ≥3*** (after 1500h) | | 4-5*** (after 1500h) | |
| | | Appearance | Rating (min) | ≥4*** (after 1500h) | | 4-5*** (after 1500h) | |
| Resistance to artificial weathering (including light fastness)** | EN 438-2.29 | Contrast | Grey Scale Rating (min) | ≥3*** (after 650 MJ/m ² radiant exposure) | | 4-5*** (after 650 MJ/m ² radiant exposure) | |
| | | Appearance | Rating (min) | ≥4*** (after 650 MJ/m ² radiant exposure) | | 4-5*** (after 650 MJ/m ² radiant exposure) | |
| Thermal conductivity coefficient | DIN 52 612 | - | W/mK | 0.25 | | 0.25 | |
| Thermal expansion coefficient | ASTM D 696 | - | °C ⁻¹ | L=1.6x10 ⁻⁵ ca. T=3.5x10 ⁻⁵ ca. | | L=1.6x10 ⁻⁵ ca. T=3.5x10 ⁻⁵ ca. | |
| Tensile strength | EN ISO 527.2 | Force | MPa (min) | L≥100 T≥70 | | L≥100 T≥70 | |
| Flexural strength | EN ISO 178 | Force | MPa (min) | L≥100 T≥90 | | L≥140 T≥100 | |
| Flexural modulus (E) | EN ISO 178 | Force | MPa (min) | L≥10000 T≥9000 | | L≥14000 T≥10000 | |
| Density | ISO 1183 | Density | g/cm ³ | ≥1.35 | | ≥1.4 | |

* Values considering that the HPL is stored in the manner and conditions recommended by the manufacturer.

** With regard to the colour fastness, for applications within the range of latitude between the 35th North parallel and the 35th South parallel and heights over 2000 m above sea level, it is advisable to contact the local Abet Laminati Sales Office to verify its possible application.

*** Excluded colour codes: 414, 416, 475, 825, 854 that perform the standard requirement of contrast "rating 3" (grey scale). It is possible to order them with an additional treatment in order to get a value of contrast with rating 4 to 5 (grey scale).



MATERIAL EXTERIOR GRADE

3.6. Reaction to fire

| Test method | Standard | Classification | | | |
|---------------------------------|-------------|-----------------|---------|-----------------|---------|
| | | EDF | | EDS | |
| Fire reaction (EU) | EN 13501-1 | t<6 mm | C-s2,d0 | t≥6 mm | C-s2,d0 |
| | | t≥6 mm | B-s1,d0 | t≥12 mm | B-s1,d0 |
| Small flame and radiant panel | UNI 8457 | Class 1 | | Class 2 | |
| | UNI 9174 | | | | |
| | UNI 9177 | | | | |
| Flame spread rate (UK) | BS 476-7 | Class 1 | | Class 2 | |
| Fire shaft test (D) | DIN4102-1 | B1 | | B2 | |
| Flammability (FR) | NF P 92-501 | M1 | | M2 | |
| Smoke toxicity and density (FR) | NF F 16-101 | F1 | | F1 | |
| Swiss fire test | VKF | 5.3 (4≤t≤10 mm) | | 5.3 (4≤t≤10 mm) | |

For the latest update of the technical datasheets we recommend to check the general Abet Laminati website (www.abet-laminati.it) or contact your local Abet Laminati representative.

3.7. Certificates

3.7.1. CE marking

In compliance with Reg. EU 305/2011 “Construction Products Regulation” (CPR), MEG F1 obtained the Certificate of Constancy of Performance of the product according to the requirements laid down in Annex ZA of the harmonized standard EN 438-7:2005; therefore, the product is CE marked. Also MEG (the non-fire retardant grade) having thickness equal to or higher than 6 mm is CE marked.

3.7.2. Certifications

Abet Laminati has obtained many relevant national product certifications for MEG and MEG F1 by Institutes such as CSTB (France), BUTGB (Belgium), KIWA (The Netherlands), DIBt (Germany), BBA (UK), ICC ES (USA). The latest version of these certificates can be asked for via your local Abet Laminati representative.

ISO 9001 and ISO 14001 certifications

In order to demonstrate the company’s continual commitment to provide a product that meets the customer requirements and to improve the Customer satisfaction, Abet Laminati has, since 2007, been certified and is compliant with the quality management system ISO 9001 Standard.

Quality and production requirements have always been at the foremost of the company’s commitment to develop and implement a policy and objectives which take into account legal requirements and environmental aspects. For this reason, also the environmental management system has been certified in compliance with ISO 14001 Standard.

FSC/PEFC certifications

The continuous commitment of the Company to implement a policy of environment protection, in particular to the promotion of responsible forest management is expressed by the latest Chain of Custody certifications according to FSC® and PEFC™ standards.



FSC® certified products and PEFC™ certified products are available on request

3.8. Environment

About 60 to 70% of MEG consists of cellulose fibres from renewable sources and the remaining part (about 30 to 40%) consists of thermosetting resin. No organic solvents, no asbestos and no heavy metals are used during the production cycle.

MEG does not release any gases, vapours, solvents or fluids.

Building waste and remains from processing can be stored and handled as materials equivalent to household waste at controlled landfills according to national and/or local regulations. Considering its high calorific value, the incineration of its scrapes allows a significant energy recovery in waste to energy plants.

Furthermore, MEG has had a positive life cycle assessment (LCA), based on standard ISO 14040 series, which aims to determine a product’s impact on the environment by taking into account the materials used, the energy consumption and the emissions in all stages of the product’s life, from manufacture through to processing the scrapped products.

3.9. Warranty

To receive the complete MEG Warranty document, please contact your local Abet Laminati representative.

4. Transport and storage

4.1. Transport

The panels should be handled with care during transport, in order to avoid damaging the edges and the decorative surfaces. Therefore, the following points should be observed:

- The MEG panels should be stacked horizontally on a flat and sufficiently supporting pallet, in order to prevent distortion or damage. Between the pallet and the first panel, place a protective PE sheet as well as on top of the stack.
- Secure the panels to the pallet using steel or nylon straps, so that they can't move and cause damage. The edges and corners should be protected.

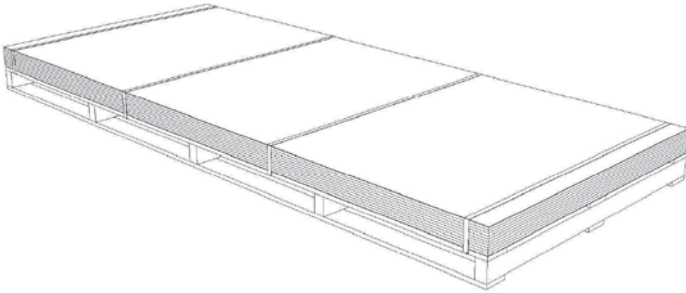

- When loading and unloading the panels, do not let them slide over each other: lift them by hand or use a lifting system with suction cups.

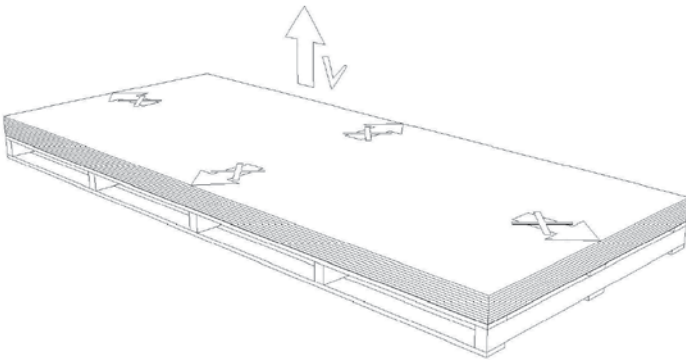

4.2. Storage

- Wrong position during storage can cause permanent deformation of the panels.

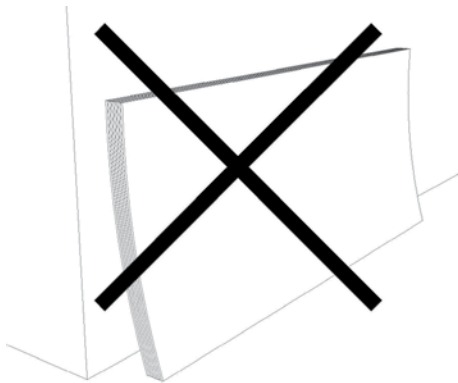

- Stack the panels on top of each other on a flat surface: never stand the panels on edge. Cover the outermost panel with a sheet of polythene or similar material.



MATERIAL EXTERIOR GRADE



MATERIAL EXTERIOR GRADE

- For temporary storage outside :
 - Cover the panels with polythene or tarpaulin to protect from climatic elements and also to avoid moisture ingress accumulating between the sheets.
 - It is strongly recommended that the delivered material remains strapped on the pallet until needed.
 - When the pallet is opened and material is used, at the end of the day, a polyethylene sheet should be placed over the top sheet and re-strapped, the whole stack of sheets should then be covered with polythene or waterproof tarpaulin, this being all the more important if the protective film has been removed.
 - The pallet should be sited on a well-drained area, so as not to stand over wet or damp. Never position the pallet over open soil as these areas are of higher ambient humidity.
 - If panels have been prepared in a workshop, re-stack in the same manner that they were received from the factory.
 - For panels which have been pre-prepared in the workshop by affixing hanging brackets etc. or for panels which may have bowed through moisture absorption to one face, these can be positioned on hard wooden or oak slats placed between the panels, with a maximum distance corresponding to the value shown on page 15 less 20%. Panels should be strapped when not being worked and covered in a ventilated way with polythene or tarpaulin.

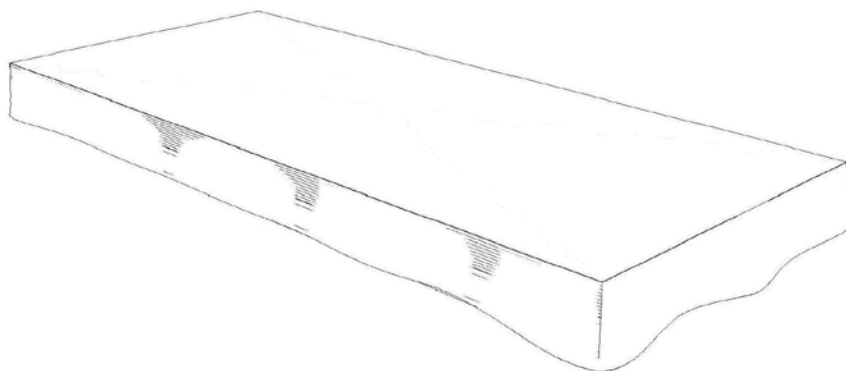

- For storage inside :
 - It is advisable to store the MEG panels in a closed warehouse under normal climatic conditions (advised temperature 10-30° C/humidity 40 to 65%).
 - When warehousing, place the MEG panels horizontally, together, on a sturdy, well supported and completely flat rack.
 - Provide a PE sheet between the supporting rack and the first panel.
 - Cover the top panel with a protective PE sheet and on top of this a larger panel that has sufficient mass to exert a downward pressure on the stack of MEG panels.

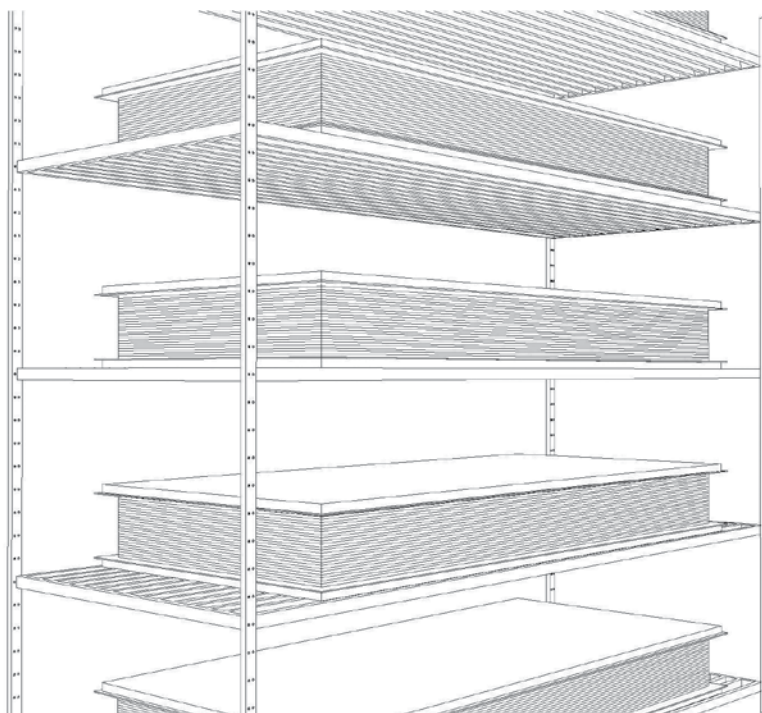

5. Processing the panels

5.1. Acclimatisation

Before processing, we suggest to leave the panels in a well-supported ventilated position for a period of 1 day per mm thickness allowing them to acclimatise, in order to prevent any distortion of the panels.

5.2. Processing conditions

- Processing MEG panels in the workshop should be done in normal climatic conditions.
- Ensure that machine surfaces are clean before laying the MEG panels on them.
- Ensure that the room is well lit and provide adequate dust extraction to be able to view the MEG panels correctly at all times while processing them.
- Before processing, check the MEG panels for any production defects. If any production defects are found in the panels, use a complaints procedure to report them immediately to the supplier, who in turn will contact the Abet Laminati representative. The costs of processing panels that had a production defect are not eligible for compensation by Abet Laminati.
- With MEG Wood panels, match the wood grain according to the design.
- With MEG Concrete panels, match the decorative pattern according to the design.
- Be careful with the direction of all MEG panels and in particular with the MEG Metal typology. Turning the panels through 90°, 180° and/or 270° results in a noticeable colour difference.

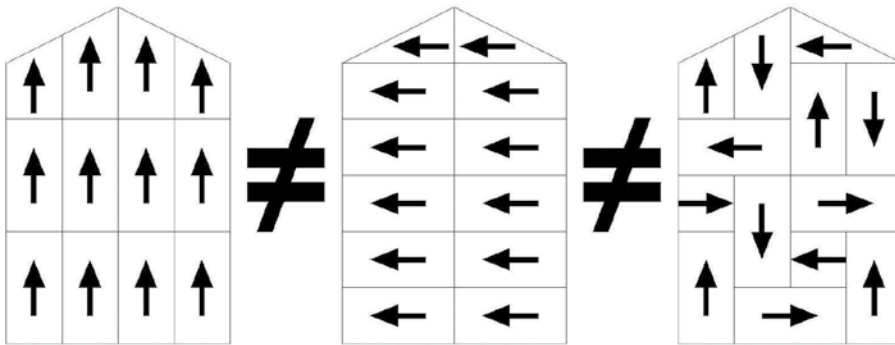

• Panel edge finishing

- It is best to finish-mill the edges of the panels after sawing, in order to be as smooth as possible to stop water accumulating.
- The edges of the panels should be chamfered at the visible side of the panel in order to eliminate burring, which could otherwise cause water and dirt accumulation.

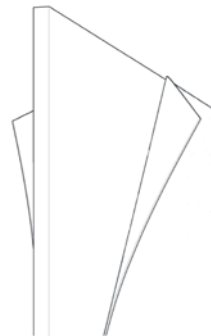

• Protection film

When a protection film is provided on the MEG it will always be applied on both sides of the panel. It is very important to rip the film off the surface at the same time of manipulation on both sides together.

Leaving for example the protection film just on the outer side of the panel in order to protect the surface from dirt and risk of damage while assembling the façade, will cause a distortion of the panel.

- When making holes or openings into MEG panels the internal corners must have a minimum radius of 4 mm.

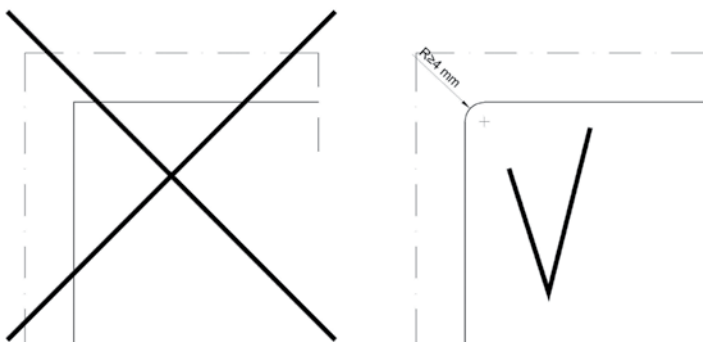

MATERIAL EXTERIOR GRADE



MATERIAL EXTERIOR GRADE

5.3. Safety instructions

- Respect the generally applicable health and safety rules.
- Wear appropriate, not loose-fitting work clothing. Avoid wearing rings, necklaces, watches or other type of jewellery and ornaments.
- Wear safety goggles and a dust mask when sawing, sanding and milling.
- Wear ear protection for noisy processing (e.g. sawing).
- Provide continuous dust extraction during machining activities.
- Wear protective gloves during activities involving adhesives, solvents or other chemical products.
- Make sure that the equipment is earthed.
- Remove adjusting spanners or wrenches before using a machine.
- Keep the workplace clean and tidy.
- Ensure that the work pieces are always stable and clamped before proceeding with processing.
- Respect the generally applicable instructions and measures concerning occupational safety and fire prevention.

5.4. Sawing

5.4.1. Types of saw

The following types of saw can be used for sizing MEG

- Panel saw/dividing saw
- Portable circular saw
- Docking saw
- Avoid the use of a pendulum saw

5.4.2. Saw blade

- A saw blade with inset carbide teeth (Widia) or diamond teeth PCD (only for non-portable saws) is recommended.
- Use a saw blade with alternating trapezoidal/flat teeth.

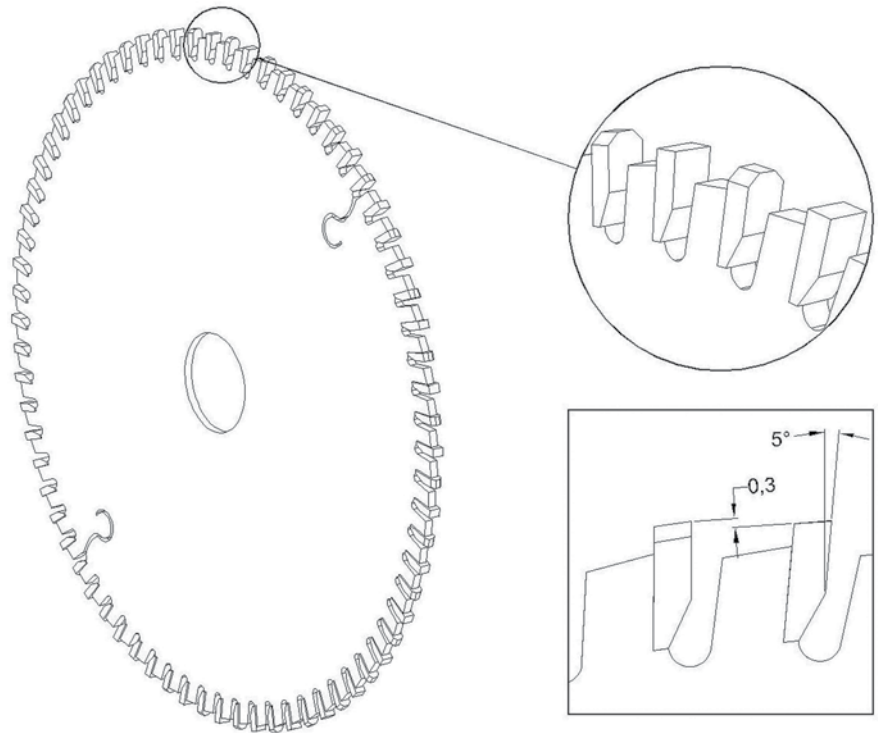

- The saw blade must have at least six teeth per 25 mm diameter.
- Usable saw blade teeth profiles:

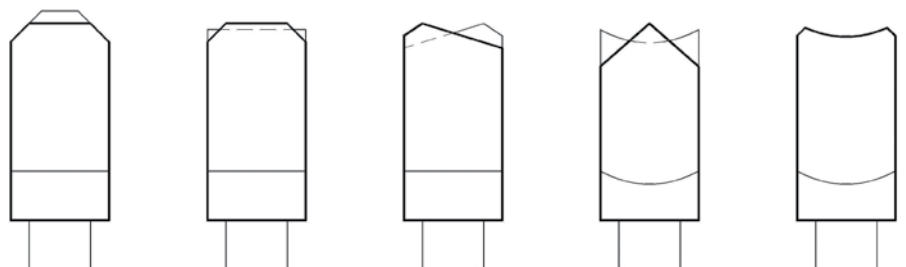

5.4.3. Cutting

Please note that the further the saw blade sits out of the panel, the sharper and cleaner will be cut on the side of the tooth entering, and the less clean the other side, and vice versa. One rule of thumb is to plan to have continuously two full teeth in the thickness of the panel.

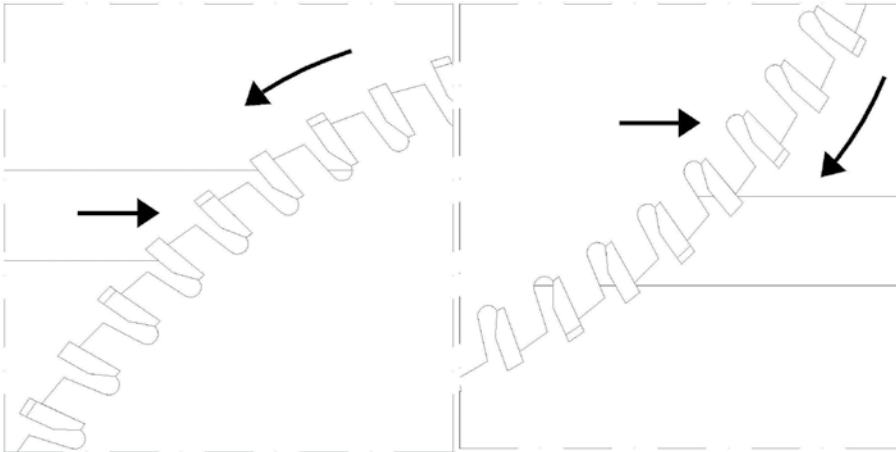

MATERIAL EXTERIOR GRADE

- **Panel saw/dividing saw**

Saw the MEG panel with the visible side up. The entry of the saw tooth into the panel is from the top and is usually the cleanest.

- **Portable circular saw**

- Saw the MEG panel with the non-visible side up. The entry of the saw tooth into the panel is from the bottom and is usually the cleanest.
- Ensure that the panel being cut is always well secured and stable.
- Always use a guide and allow a margin for edge milling.
- Manual sawing with a portable circular saw should be limited to specific interventions on site.

- **Docking saw**

Saw the MEG panel with the visible side up.

- **Pendulum saw**

Saw the MEG panel with the non-visible side up. Saw cuts obtained using a pendulum saw will not be clean. To create openings and recesses, it is better to opt for a router or milling by CNC.

- Ideally, each saw cut should be finish-milled. It is also advisable to mill a slight chamfer (bevel edge) on the edges of the panel, in order to prevent burring, so that water accumulation at the edges is impossible. This guarantees a perfect finish and improved resistance to rain, frost and other climatic conditions over time.

5.5. Milling cutters

5.5.1. Milling machines

- Routers
- Bench mill
- CNC milling machine

5.5.2. Types of milling cutter

- Tungsten Carbide or Wolfram Carbide (Widia) milling cutter gives the best result when sharpened but doesn't last very long due to the abrasive characteristic of MEG.
- Diamond milling cutters (PCD)
 - Longer lifespan
 - Higher performance
 - Constant cutting quality
 - More expensive to buy
- The milled edge will be satisfyingly flat depending on the milling cutter profile.
- Specialist suppliers offer a wide range of shaped profile cutters for milling different edge profiles. There are also companies specialising in making milling cutters to order (carbide and diamond).



MATERIAL EXTERIOR GRADE

5.5.3. Milling

- Routers
 - Processing manually with a router should be limited to specific interventions on site.
 - Ensure that the panels to be processed are stable and well secured.
 - Preferably, use a guide or template. Adjust cutting speed to suit the diameter of the router, in order to prevent burring and overheating.
- Milling bench
 - Ideal for milling a rebate (butting edge) for making joints suitable for assembly according to the shiplap joining principle. The milling bench can also be used for bevelling the edges of the panels.
- CNC milling machine
 - A CNC milling machine is the ideal tool for preparing and processing panels in the workshop (drilling, milling, etc.). This machine is indispensable for the precision drilling of blind holes in preparation for placing panel hooks when building a façade with invisible, mechanical fixings.
- Milling speeds and power depend on the type of cutter, the cutter diameter, the amount of the material to be removed and the machine. It is therefore appropriate to make a test piece for setting the correct parameters.

5.6. Drills

- Ideal are helicoidal drills with a drill point angled at 60° to 80° (instead of 120° for conventional metal drills) and with steep chip evacuation (so-called rapid inclination) and a wide channel. It is advisable to place the panels to be drilled on a sacrifice board, so that the hole will stay clean on both sides.

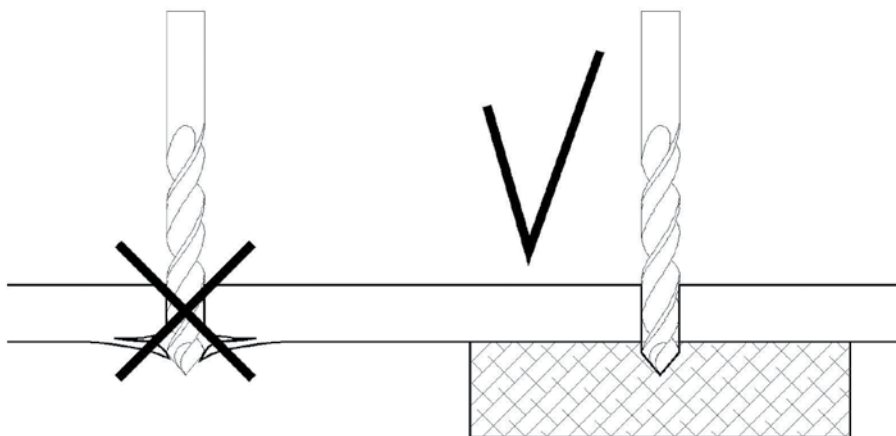

- Hole saws may be used for large diameters. In order to prevent chipping, it is also advisable to place the panels to be drilled on a sacrifice board.

6. Façade application

General

National and local building guidelines, obligations and legislation are assumed to be known by the client, architect, contractor and its subcontractor if any. These guidelines and legislations should be respected and applied by way of priority. If the local building guidelines, obligations and legislation conflict with the advice and processing guidelines of the MEG processing manual, then the client, the contractor or its subcontractor if any and/or the architect should contact the local Abet Laminati representative for consultation.

6.1. Principle of a ventilated façade

- The principle is that a naturally ventilated cavity is created between, the bearing structure insulated on the outside and the cladding secured to it.
- MEG panels used as ventilated façade provide resistance to all possible effects of the weather (sun, rain, snow, heat, frost, etc.).
- A well realized ventilated façade has the following benefits:

- The ventilated cavity allows any infiltrating rainwater (with open joints) and condensation to drain away and to dry. This is also a benefit for a long term qualitative insulation that doesn't become wet. A joint profile can prevent rainwater infiltration thereby greatly reducing the amount of moisture behind the panel. Using a joint profile (e.g. aluminium omega profile) also gives the façade a neatly finished appearance.

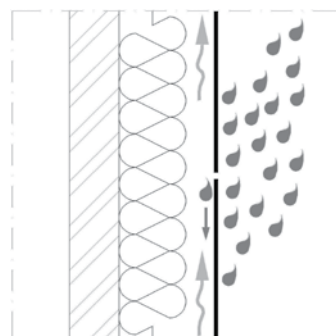

- Regulates moisture and temperature fluctuations. Thanks to the flexibility of fixing of a ventilated façade, the thickness of the thermal insulation could be adapted to the local needs and regulations. Due to the differential between the temperature and the damp pressure of bottom and the top of the building, a natural air flow will be created (chimney effect) behind the MEG cladding. This natural airflow has also the advantage to dry moisture and condensation. Moisture from the construction and condensation from the use of the building could evaporate through the ventilated gap behind the panels. The result will be a breathing building which will contribute to a healthy and pleasant inner climate. If condensation should appear, at any point inside the building, it is advisable to include a vapour barrier as well as a ventilation system for the building. Everything will depend on which side the point of condensation will be reached, if any.

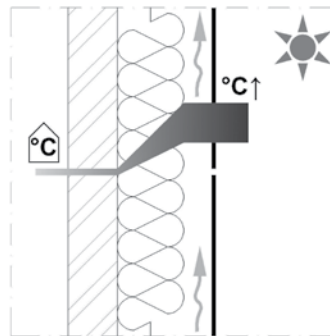
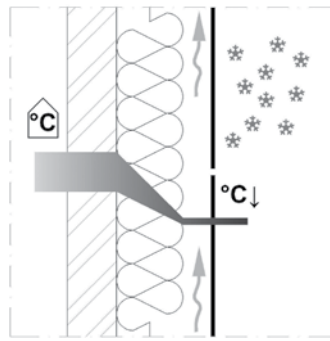

- Stabilises any structural setting of the building thanks to the external insulation of the bearing construction, which allow, low temperature variations at the inside of the building. This minimises also the risk of cold bridges.

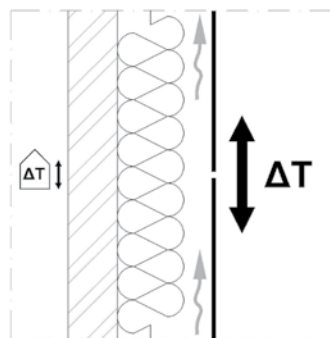

- Could isolate undesirable noises. Due to the composition of the façade in different layers the noise frequencies are reduced on different levels. It is even possible to improve this effect by adding specific sound reduction isolation.

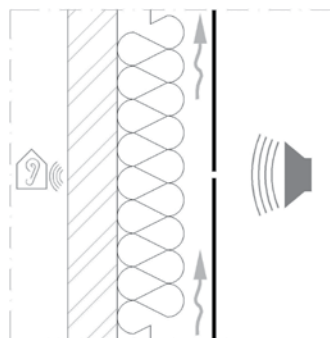

- Could function as a lightning arrester. With a ventilated façade it is easy to have an improved fire safe cladding by using fire resistant materials for the insulation, sub construction and cladding (MEG F1 for example). It is also necessary to place stainless steel fire partitions between the storey levels in order to prevent the fire to propagate through the ventilation cavity.

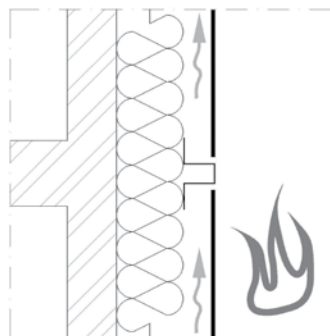



MATERIAL EXTERIOR GRADE

- For a naturally ventilated cavity the following should be taken into account:
 - Sufficient air inlet openings at the bottom of the cladding and sufficient air outlet openings at the top of the cladding. It is also necessary to provide them at window sills and at window and door lintels. Minimum $50 \text{ cm}^2/\text{m}$ for façade parts 3 m height (uninterrupted opening of 5 mm) and minimum $100 \text{ cm}^2/\text{m}$ for façade parts >3 m height (uninterrupted opening of 10 mm). The size of the air inlet and outlet openings should be proportioned according to the height of the cavity to be ventilated with a maximum opening equal to the depth of the cavity.
 - A cavity should be at least 20 cm wide and minimum 2.5 cm deep.
 - The continuity of open air circulation in the cavity.
 - Masking of ventilation openings with perforated screens and/or perforated profile of openings > 1 cm, in order to stop vermin and insects accessing the rear of the cladding. Be careful to respect the minimum % of opening required through the perforated openings of the screens.
 - For horizontal panel application it is necessary to have the sub-construction orientated perpendicularly to the façade cladding, in order to allow a natural airflow for ventilation between the "warm" side of the building and the cold exterior, it will also be necessary to reduce the distance between the bearing sub-construction.

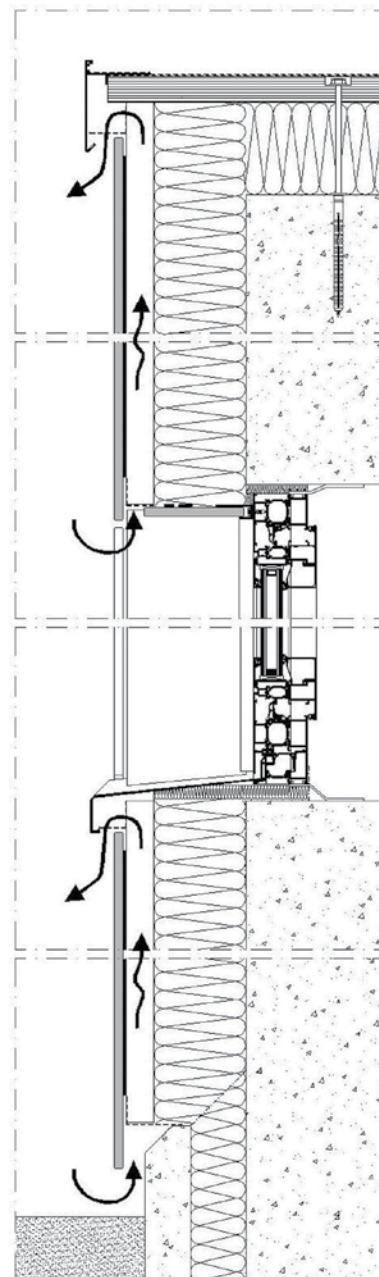

6.2. Joints

- Temperature and humidity affect the panel dimensions. This should be taken into account when determining the joint width between panels. Generally, a dilatation gap should be calculated as 0.15% of the length of the panel for the longitudinal direction and 0.3% of the width for the transversal direction.

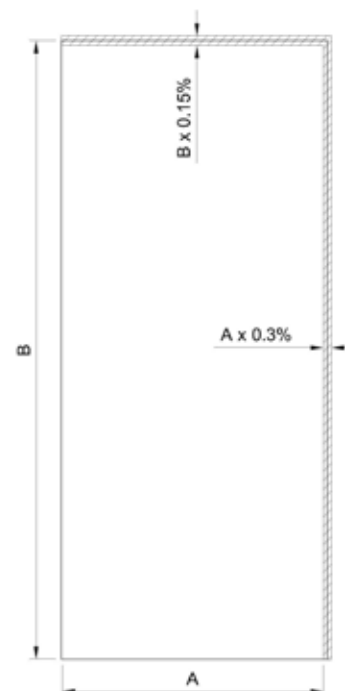



MATERIAL EXTERIOR GRADE

- A minimum gap of 6 mm is required. This has not only a technical but also an aesthetic function. How smaller the joints, how more joint width differences will be visible.
- If a profile (aluminium or plastic) is placed in the joint, spacing should be allowed on both sides of the profile equal to half the joint width.
- For aesthetic considerations, it is best to mask the joints, but also in order to prevent insects and vermin nesting behind the panels.
- An open joint façade cladding is less subject to wind suction effect on the panels.
- At open joints, any potential rain or damp infiltration, can adversely affect the insulation. Placing a vapour permeable moisture barrier can be a solution for this.
- Where air supply and extraction needs to be provided, the openings must be closed off with specially designed perforated screens and/or perforated profiles, in order to prevent access by vermin and insects behind the cladding.

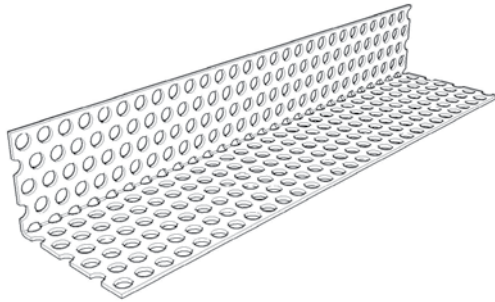

- It is not advisable to use sealant in expansion joints; this leads to stresses in the panel that could prevent natural movement and cause the panel to deform.

- Optionally a drip edge profile could be used in order to prevent collecting and stagnating on the edge of the panel and also in order to avoid water infiltration behind the MEG panel which could cause deterioration of the backing subconstruction, especially with timber supporting structures.

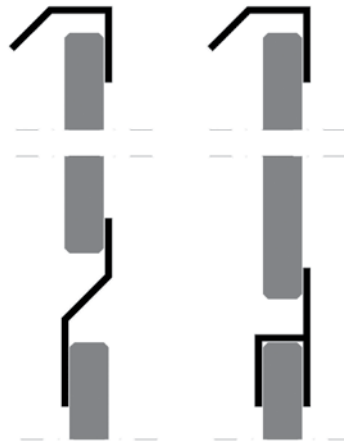

- Joints in the MEG façade cladding must coincide with the dilation joints of the subconstruction.



- Types of joints, horizontal and vertical:

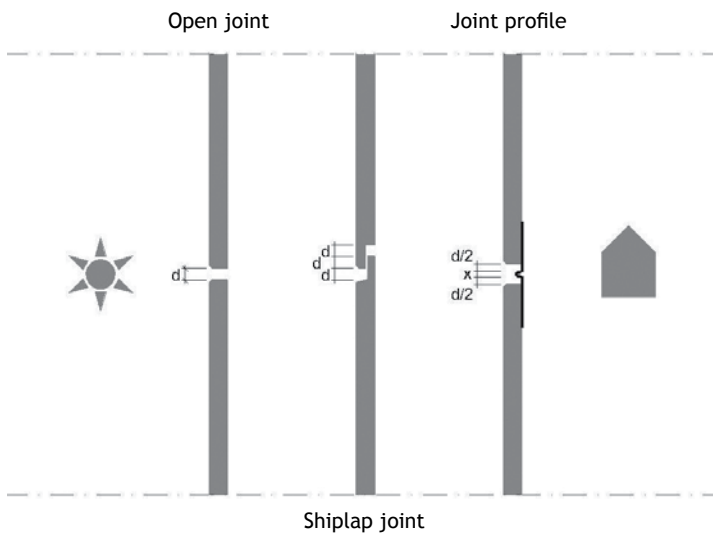

6.3. Corner solutions

- Corners can be open or closed.
- If corners are closed without any possibility of the joint opening and closing, the panel dimensions on either side of the corner may not exceed 300 mm. If they do exceed 300 mm, the corner has to be considered as fixed and the following dilatation gap should be twice the calculated width.

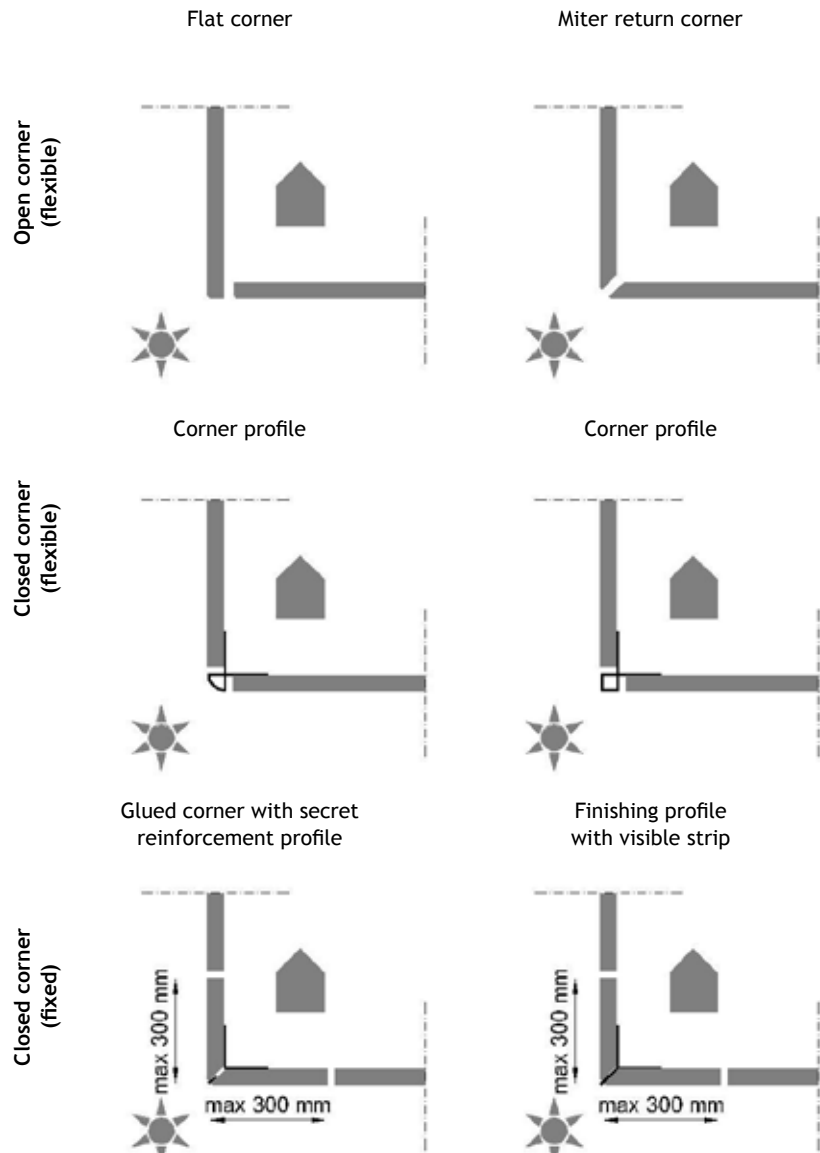

6.4. Fixing plan

- The fastening spacing indicated in the tables here under are indicative for the stability of the panel. They do not take into account wind loads, specific regional regulations, geographical location of building and physical location of the panel on the façade.
- This spacing does not take into account the type of the bearing construction on which the subconstruction is fixed or the type of the subconstruction itself.
- Abet Laminati recommends that the spacing distances should be as per a structural engineering calculation taking into account all above mentioned factors.
- For glued applications the spacing measurements should be reduced by 20%.
- For horizontal or inclined applications the spacing measurements should be reduced by 20%.
- If horizontal or inclined applications are glued, these measurements should be reduced by an additional 20%. This means a total of minus 36% on the values indicated below.



MATERIAL EXTERIOR GRADE

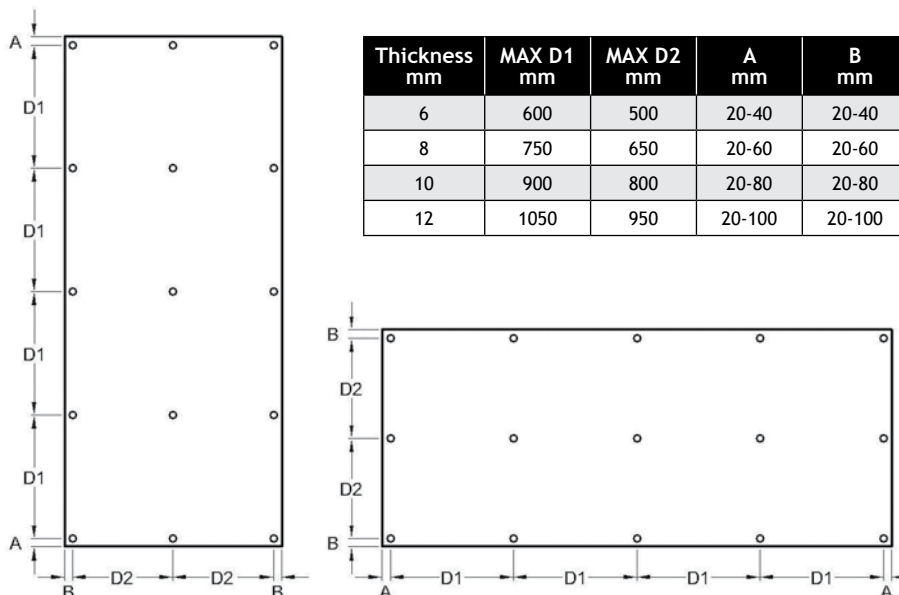
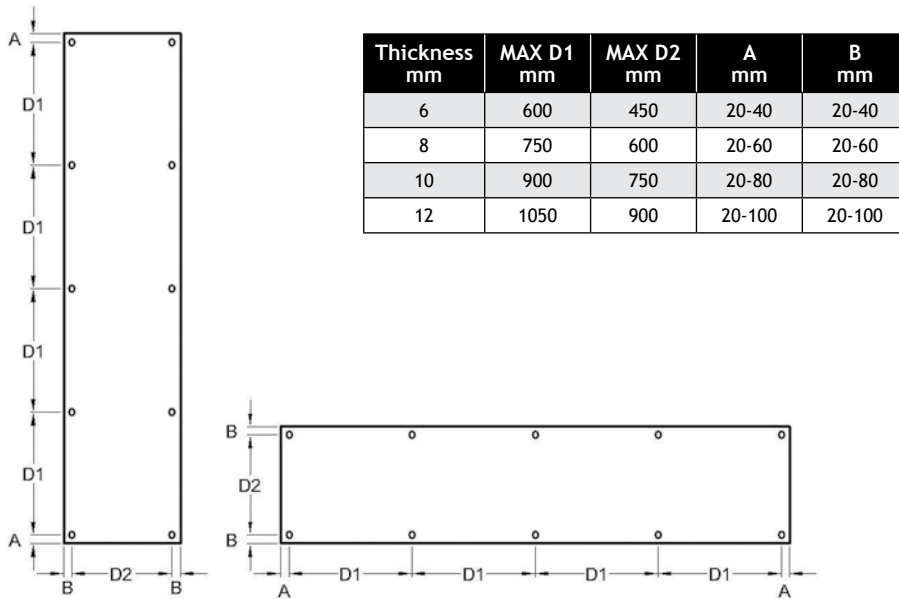



MATERIAL EXTERIOR GRADE

6.5. Fixing systems

6.5.1. General guidelines

The following important points should be observed when using and dimensioning Abet Laminati MEG panels:

- MEG panels are self-supporting and must be mounted to be freely suspended, so that they remain ventilated along the front and rear faces (e.g. not fastened onto a solid carrier or on a full background).
- The strength and stiffness of the panels should be viewed as a function of the thickness of the panel in conjunction with the planned backing structure and type of fixing.
- The panels should not be given any structural or stabilising functions.
- If any heavy elements are to be hung from the panels, it is advisable to secure them to the underlying structure. Note: the free expansion/contraction of the panels must be respected by providing enough clearance around the fixings.
- MEG panels should always be applied with free ventilation.
- Expansion joints should always be allowed between the panels themselves and between the panels and any potential obstructions.
- A minimum gap of 6 mm is required. A joint of 10 mm is recommended, covering all possible dimension changes within a panel, taking in account normal climatic variations.

6.5.2. Types of structure

A few points of attention are common to all kind of subconstructions:

- Fixing points to the bearing structure of the building should have at least a pull out strength of 3 KN. On site tests could be realized with the supplier of the anchors and/or of the subconstruction.
- For anchoring a subconstruction always refer to the directives of the supplier of the proposed anchors.
- A subconstruction, in whatever material is used, should never have a flatness tolerance larger than $L/1000$ over the whole surface of the façade and should never exceed 2 mm/m between the fixing points of the panels.
- Always take in account the dilatation of the material used as subconstruction especially at linear prolongations. Mostly a dilatation gap will be required.
- Dilatation gaps of the MEG panels and the subconstruction should always coincide.



6.5.2.1. Vertical wooden battening with wooden substructure

Vertical pressure treated timber structure (minimum profile of 30x40 mm for intermediate and end battens and of 30x80 mm for battens at joints) mounted on a horizontal pressure treated timber battening, which in turn is secured to the underlying building structure. This method is usually used for timber frame buildings, in order to avoid a less homogeneous insulation of the building occurring near the primary horizontal timber structure in case of traditional building.

Advantages:

- Inexpensive supporting structure.
- Horizontal timber subconstruction is simple to fix to building structure.
- Flexibility for determining the centre-to-centre distance when placing the vertical timber structure.
- Independent vapour permeable wind and water barrier is simple to install.
- A horizontal finishing joint profile (e.g. Omega profile) is simple to install.

Disadvantages:

- Hard to control the relative moisture content of the wood.
- In time wood could be deteriorate by ageing.
- The wood may twist or buckle.
- In case of traditional building structure (not timber frame building) the insulation will be less homogeneous near the primary horizontal wooden structure.
- Cold bridges at the point fixings in the building structure in case of traditional building.
- Since it is imperative to obtain a perfectly flat supporting subconstruction, great care and time could be spent on setting the primary wooden structure matrix, depending on the flatness of the bearing construction.

6.5.2.2. Vertical wooden battening with double wooden substructure

Vertical pressure treated timber structure (minimum profile of 30x40 mm for intermediate and end battens and of 30x80 mm for battens at joints) mounted on a horizontal pressure treated timber structure, which in turn is secured to the underlying vertical timber structure which is secured to the bearing construction of the building. In this case you obtain a double layered insulation which guarantees a homogenous insulation of the building and of the substructure.



MATERIAL EXTERIOR GRADE

Advantages:

- Inexpensive supporting structure.
- Horizontal wooden subconstruction is simple to fix to building structure.
- Flexibility for determining the centre-to-centre distance when placing the vertical wooden structure.
- A double layered insulation guarantees a homogenous insulation of the building and of the substructure.
- No cold bridges at the point fixings in the building structure.
- Independent vapour permeable wind and water barrier is simple to install.
- A horizontal finishing joint profile (e.g. Omega profile) is simple to install.
- Good ventilation of the wooden structure.

Disadvantages:

- Hard to control the relative moisture content of the wood.
- In time wood could deteriorate by ageing.
- The wood may twist or buckle.
- Since it is imperative to obtain a perfectly flat supporting subconstruction, great care and time could be spent on setting the primary wooden structure matrix, depending on the flatness of the bearing construction.

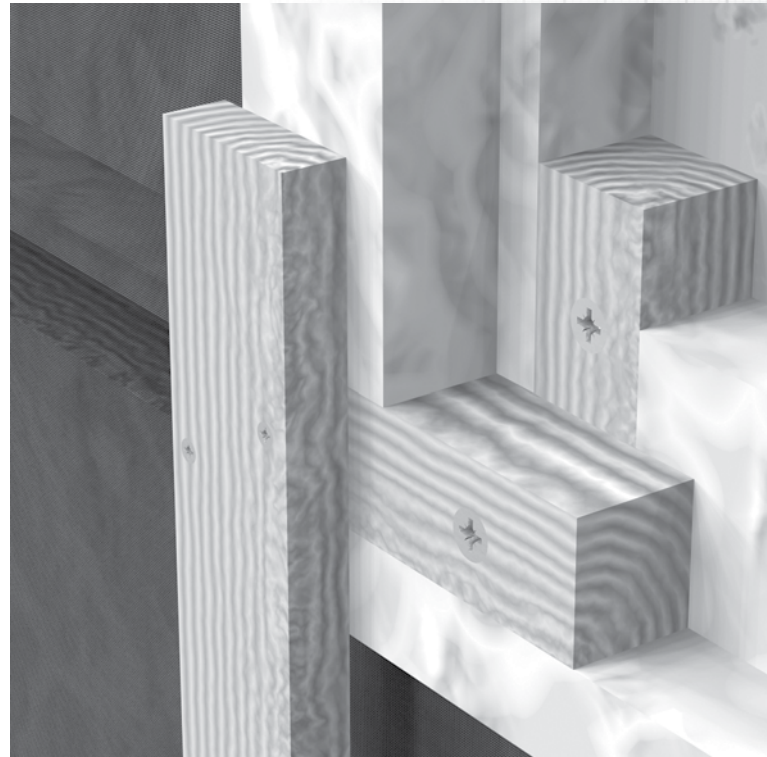

6.5.2.3. Vertical wooden battening with aluminium or galvanised steel anchoring

Vertical Pressure treated timber structure (minimum profile of 30x40 mm for intermediate and end battens and of 30x80 mm for battens at joints) secured using aluminium fixing anchors directly into the underlying building structure.

Advantages:

- Inexpensive supporting structure.
- Flexibility in setting the wooden support structure matrix, completely independently from the flatness of the building structure.
- Completely homogeneous insulation of the building is possible.
- A horizontal finishing joint profile is simple to add (e.g. Omega profile).
- Flexibility in choosing the insulation thickness.

Disadvantages:

- The centre-to-centre distance of the aluminium fixing anchors must be placed very carefully in order to provide the adequate subconstruction on the right place for the panel fixing.
- Harder to place an independent vapour permeable, wind and water barrier. It is best to fit insulation already provided with a vapour permeable, wind and water barrier or to use wind and water resistant insulation panels.
- Hard to control the relative moisture content of the wood.
- The wood may twist or buckle.
- In time wood could deteriorate by aging.





MATERIAL EXTERIOR GRADE

6.5.2.4. Vertical wooden battening with distance anchoring

Vertical Pressure treated timber structure (minimum profile of 30x80 mm for battens) secured directly into the underlying building structure through the isolation, using special distance anchors. In this case it is advisable to use hard insulation panels like PIR, PUR, cellular glass,...

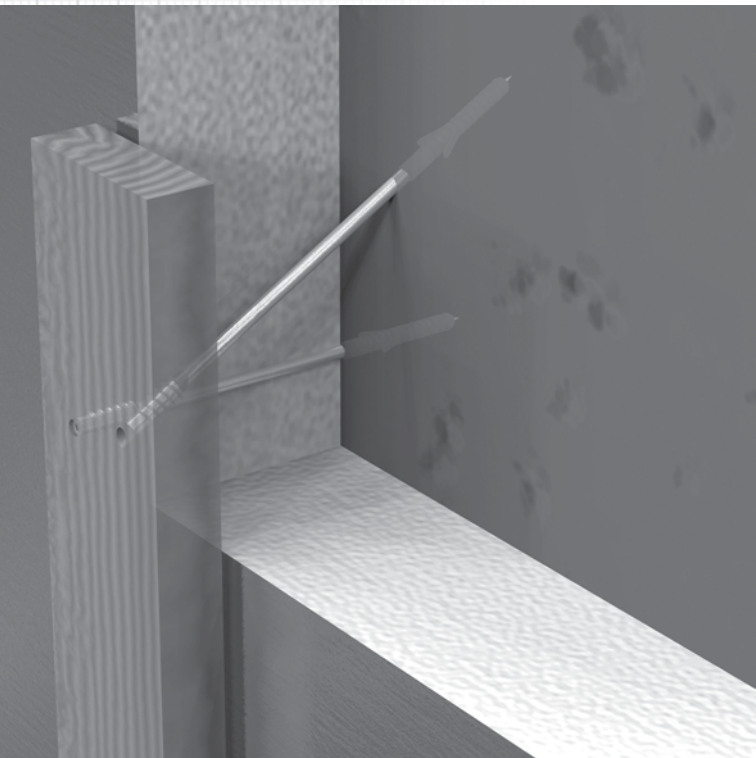

Advantages:

- Inexpensive supporting structure.
- Flexibility in setting the wooden support structure matrix, completely independent from the flatness of the building structure.
- Completely homogeneous insulation of the building is possible.
- A horizontal finishing joint profile is simple to add.
- Flexibility in choosing the insulation thickness.
- Good ventilation of the wooden structure.

Disadvantages:

- The centre-to-centre distance of the fixing anchors must be placed very carefully in order to provide the adequate subconstruction on the right place for the panel fixing.
- Hard to control the relative moisture content of the wood.
- The wood may twist or buckle.
- In time wood could deteriorate by ageing.

6.5.2.5. Vertical aluminium Omega and Z profiles with distance anchoring

Vertical aluminium Omega profiles at joins and Aluminium Z intermediate aluminium profiles secured directly into the underlying building structure through the isolation, using special distance anchors. In this case it is advisable to use hard insulation panels like PIR, PUR, Foamglas,...

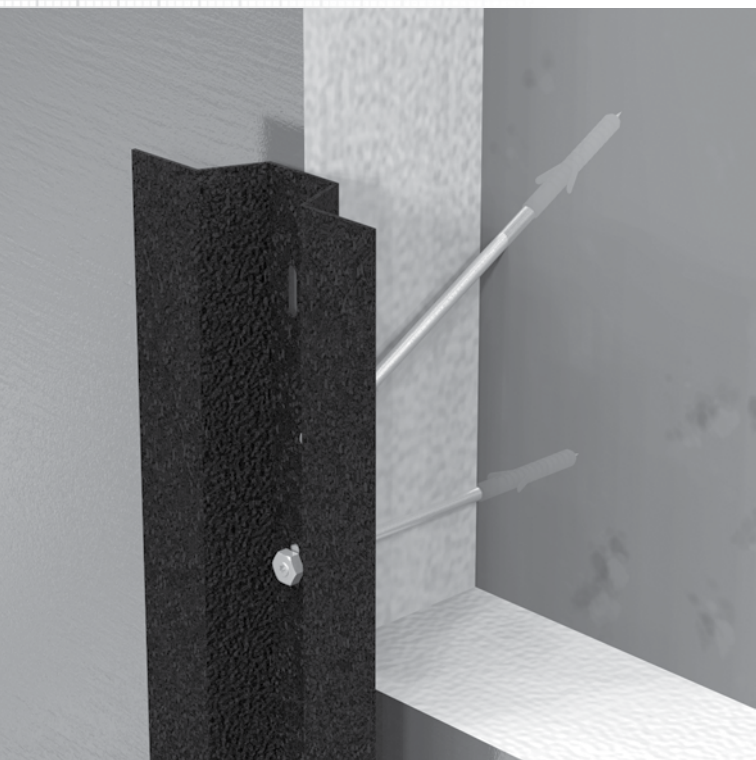

Advantages:

- Inexpensive supporting structure.
- Flexibility in setting the aluminium support structure planar, completely independently from the flatness of the building structure.
- Completely homogeneous insulation of the building is possible.
- A horizontal finishing joint profile is simple to add.
- Flexibility in choosing the insulation thickness.

Disadvantages:

- The centre-to-centre distance of the fixing anchors must be placed very carefully in order to provide the adequate subconstruction on the right place for the panel fixing.

6.5.2.6. Vertical aluminium profile with aluminium anchoring

Vertical aluminium structure, which in turn is secured with aluminium fixing anchors into the underlying building structure.



MATERIAL EXTERIOR GRADE

Advantages:

- Flexibility in setting the aluminium support structure flat and/ or perpendicular, completely independently from the flatness of the building structure.
- Fixing anchors are simple to place.
- Completely homogeneous insulation of the building is possible.
- A finishing joint profile is simple to add (e.g. Omega profile).
- Stable, homogeneous and strong yet lightweight structure that is not subject to twisting and warping.
- Highly resistant to water and moisture. An aluminium structure is more durable than wooden battening.

Disadvantages:

- Expensive compared to wooden battening.
- Expert and accurate positioning is required, taking into account such things as the expansion of the aluminium, both at the anchorages and at the expansion joint of the aluminium profile and the expansion joint of the MEG panels, which mandatorily must coincide.
- The aluminium fixing anchors must be observed very carefully (centre-to-centre distance).
- Harder to place an underlying, independent vapour permeable, wind and water barrier. It is best to fit insulation already provided with a vapour permeable, wind and water barrier or to use wind and water resistant insulation panels.



6.5.3. Types of fixing

6.5.3.1. Visible mechanical fixing

6.5.3.1.1. General principles

- Always allow for the expansion of the MEG panels. Apart from one point (fixed point), each hole should have a clearance (dilatation point). It is very important for the screw or rivet to be positioned central in the hole, in order to allow expansion and contraction in all directions.

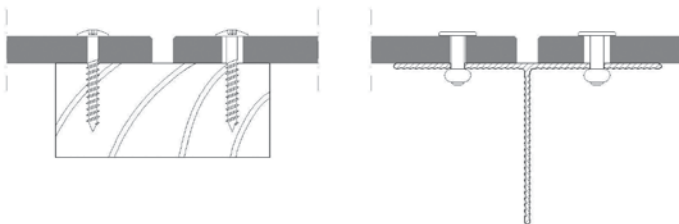

- The so-called fixed point should prevent a panel displacing due to successive expansion and contraction, thus disrupting the regularity of the joints over time. Generally the fixed point is placed as central as possible on the panel surface. The fixed point should be systematically located on the same place of the panel.

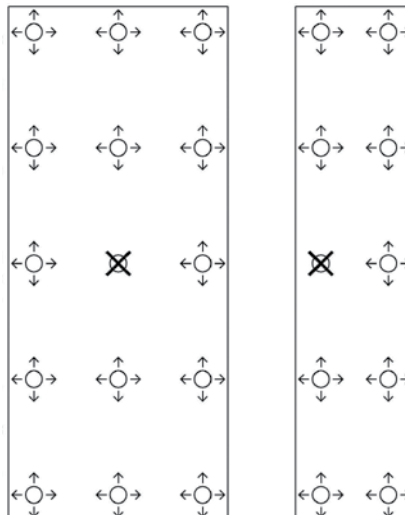

- Optionally (even sometimes obligatory) an EPDM joint band, with or without lips and eventually self-adhesive, could be applied between the MEG panel and a wooden supporting structure in order to protect the wood from external moisture. The EPDM joint band should be larger than the wooden support especially when there are no lips.

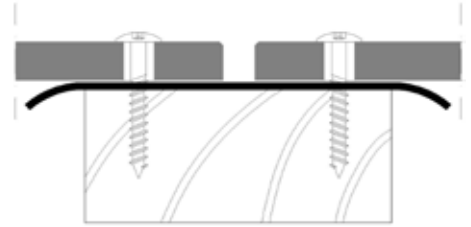

- It is also very important only to hand-tighten the screw at each dilatation point (not too tight) and for the same reason to place a suitable nose-piece over the riveting tool (as spacer device) when fitting the rivets, in order to allow panel movements at sliding point. The riveter head should allow a clearance of 0.3 mm.

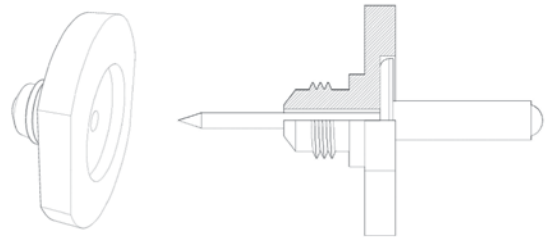

- When pre-drilling holes in aluminium sub-construction for a riveted application, it is advisable to use a drilling template or a centre drill-bit in order to position the hole in the fixing structure centred relative to the hole in the panel.

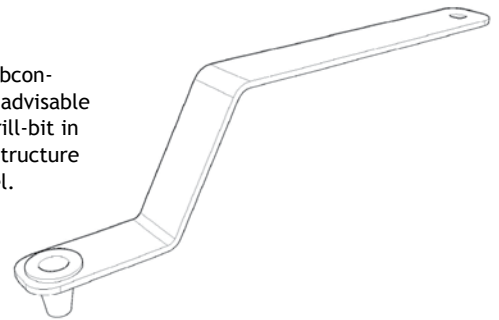

- A maximum panel dimension should be calculated at the furthest fixing point and is depending on the relatively small expansion gap that must be provided between the fixing device diameter and the hole diameter of a sliding point. The head of the fixing device should always cover the complete sliding fixing point hole. The maximum MEG panel size for visible mechanical fixing must never exceed 3030 X 1280 mm.

6.5.3.1.2. Visible mechanical fixing on a wooden backing structure

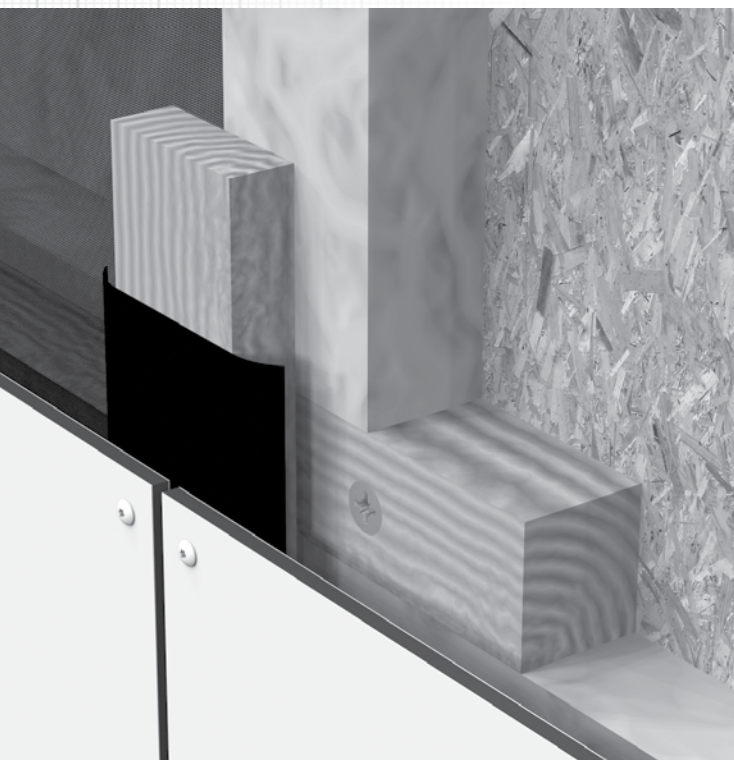

Fixing with optionally colour coated 12 or 16 mm stainless steel pan head screw, with 4.8 mm shank, Torx insert no. 20 and a length of 38 mm.

With this fixing method the diameter of the holes for dilatation and fixing points should not exceed respectively 8 mm and 5 mm for a screw head with a diameter of 12 mm, and 10 mm and 5 mm for a screw head with a diameter of 16 mm.

The dilation gap between the hole diameter and the screw diameter must allow the panel to expand/contract. A maximum panel dimension should be calculated taking into account the maximum panel dilatation at the furthest dilatation fixing point (sliding point). The head of the fixing device should always cover the complete sliding fixing point hole.

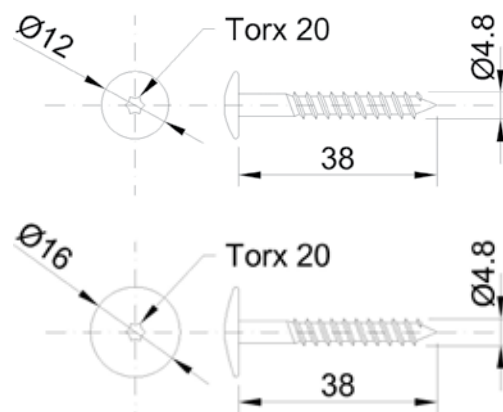

Horizontal section

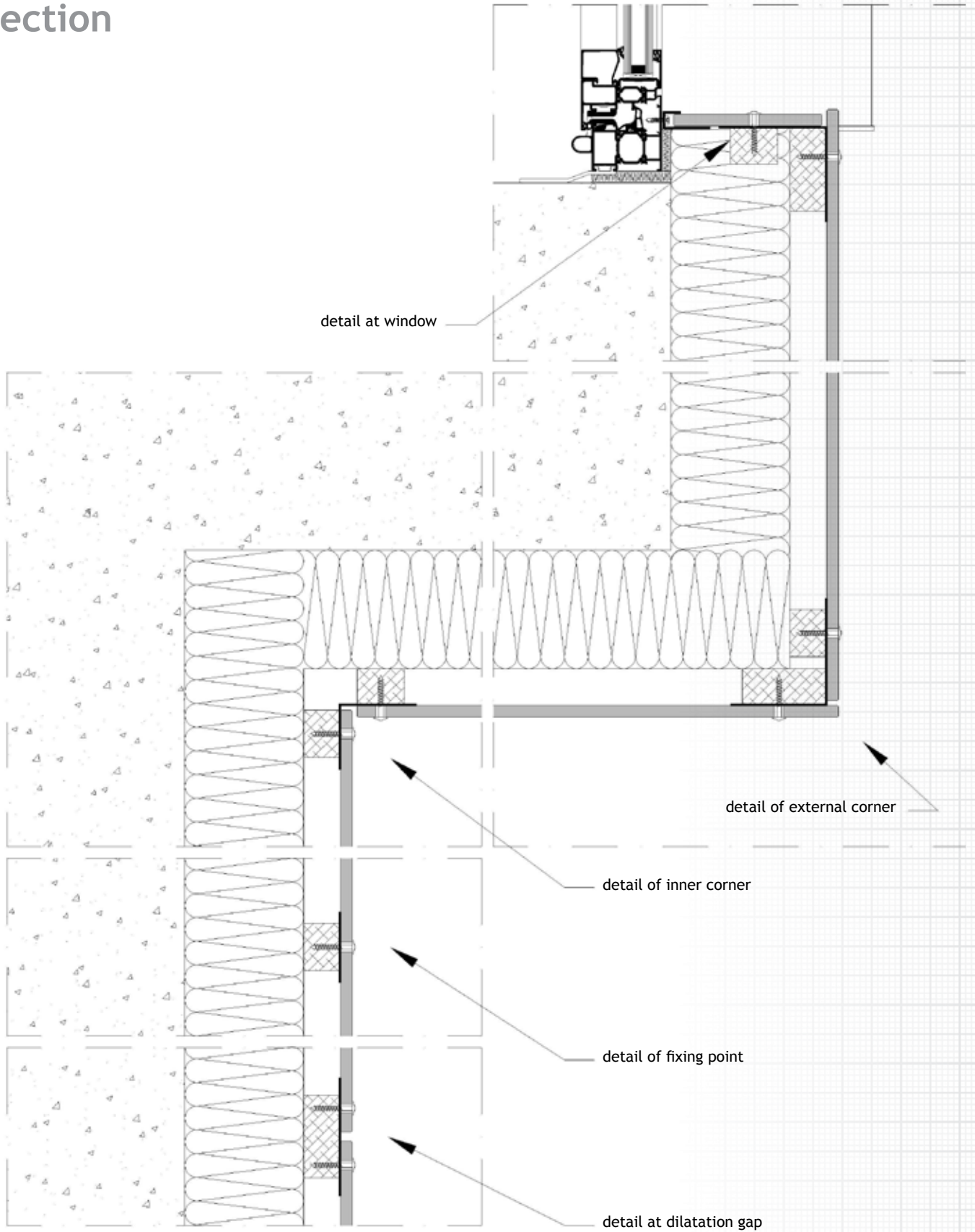



MATERIAL EXTERIOR GRADE

Vertical section

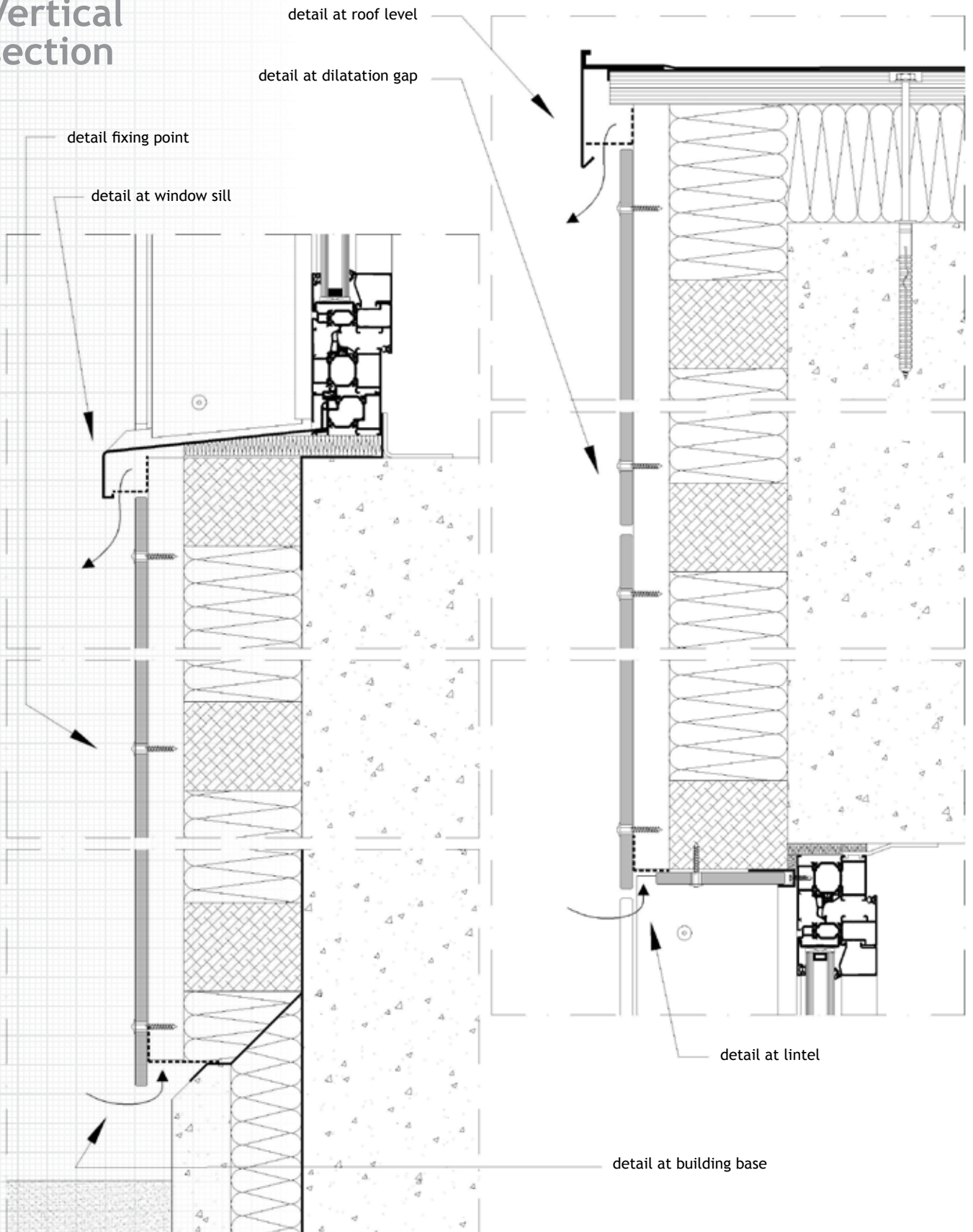

6.5.3.1.3. Visible mechanical fixing on an aluminium backing structure

- Fixing with optionally colour coated 16 mm stainless steel self-drilling and tapping pan head screw with 6 mm shank, Torx insert no. 25 and a length of 25 mm, are used for this type of fixing.

With this fixing method the diameter of the holes for dilatation points should not exceed 10 mm, and 6 mm for the fixing point. The dilation gap between the hole diameter and the screw diameter must allow the panel to expand/contract. A maximum panel dimension should be calculated taking into account the maximum panel dilatation at the furthest dilatation fixing point (sliding point). The head of the fixing device should always cover the complete sliding fixing point hole. The use of centering sleeves is possible but it will limit the dilatation of the sliding points.

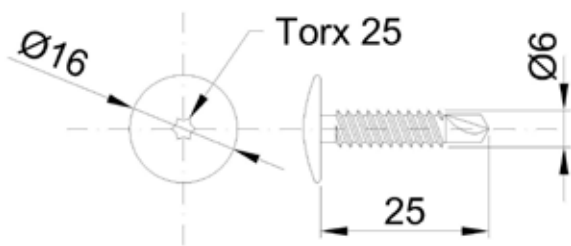

- Fixing with optionally colour coated 16 mm broad head rivet with stainless steel nail and aluminium 5 mm mandrel. Respect the length of the rivet advised by the supplier of the rivet taking in account the sum of the different thicknesses material to be joined. With this fixing method the diameter of the holes for dilatation points should not exceed 10 mm and 5,1 mm for the fixing point. The dilation gap between the hole diameter and the rivet diameter must allow the panel to expand/contract. A maximum panel dimension should be calculated taking into account the maximum panel dilatation at the furthest dilatation fixing point (sliding point). The head of the fixing device should always cover the complete sliding fixing point hole.

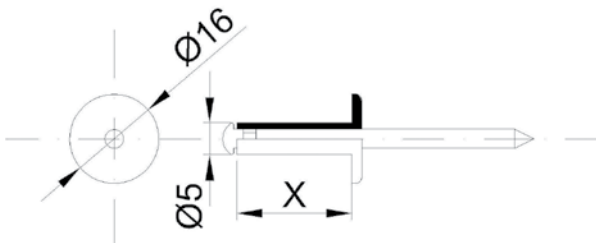



MATERIAL EXTERIOR GRADE

Horizontal section

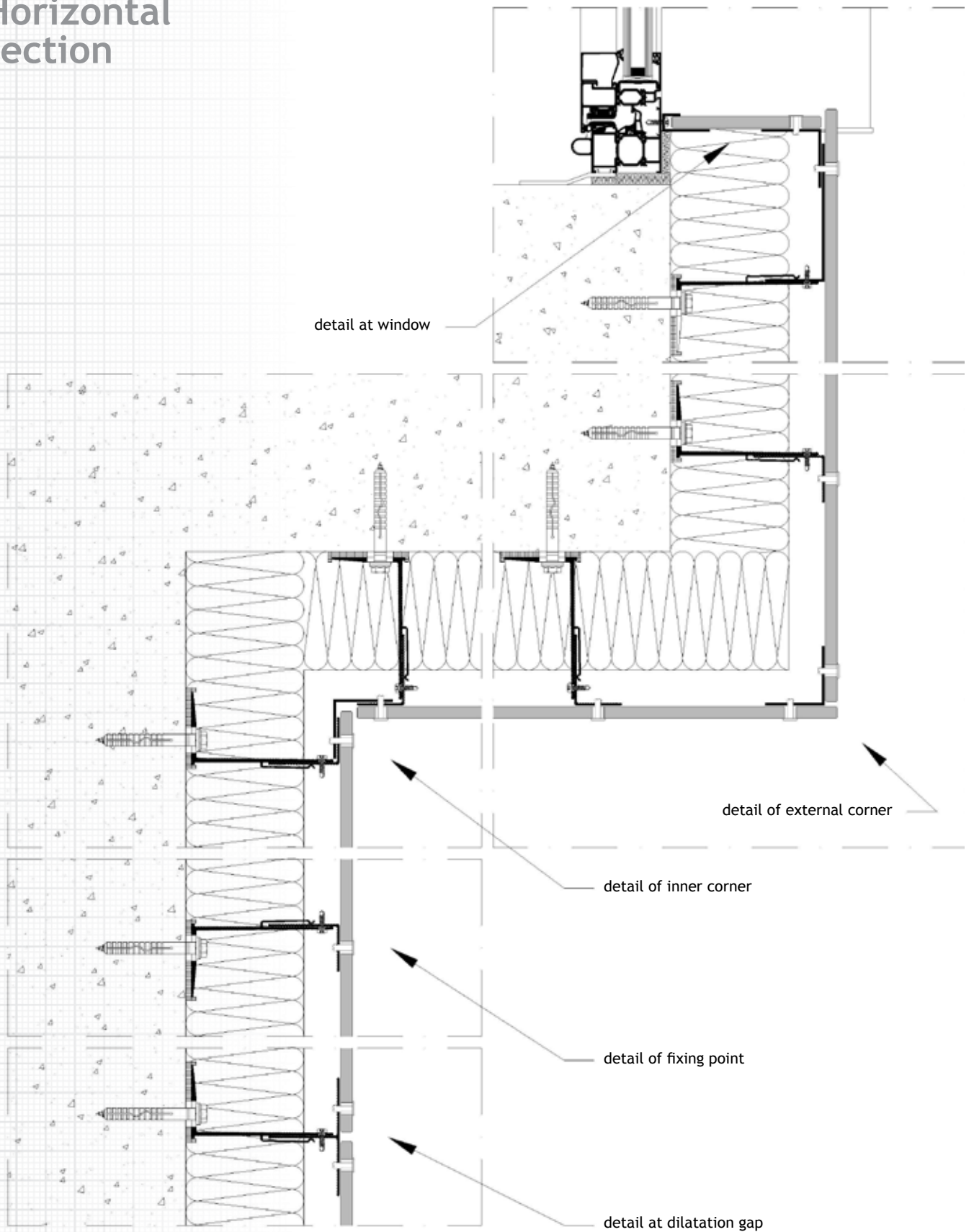

Vertical section

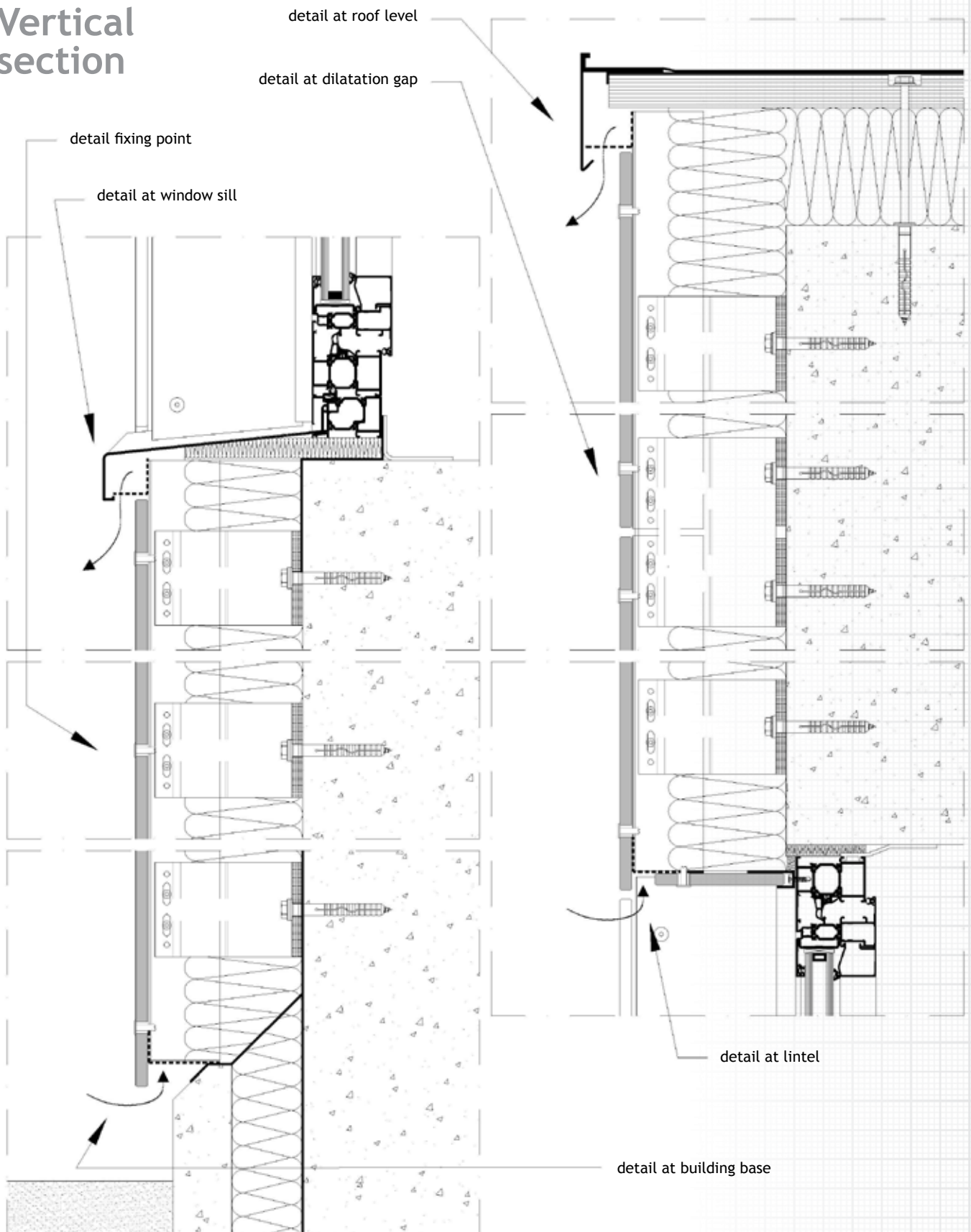



MATERIAL EXTERIOR GRADE

6.5.3.2. Gluing on wooden substructure

- MEG panels can be bonded with a flexible MS polymer or polyurethane adhesive system for façade cladding. Please note that processing times, open times, minimum and maximum application temperatures and application methods do vary depending on the adhesive manufacturer. Please consult the adhesive manufacturer's processing guidelines.
- When gluing MEG always use a single-sided decorative MEG panel with a backing reference on the reverse side of the panel. Always glue on the backing side of the MEG panel. Contact your local Abet Laminati representative for the up-to-date list of concerned MEG decors.



- A maximum panel dimension has to be respected in conformity with the tolerated panel dilation depending on the flexibility and strength of the glue. Refer to the glue manufacturer for the maximum authorised diagonal dimension of the panel.
- The wood should be treated with a primer. Care: before applying the primer, check the moisture content, which must not exceed a maximum percentage and is specified by the chosen adhesive manufacturer. That percentage is usually around 18%.
- The adhesive manufacturer also specifies the maximum activation period (open time) of the primer. The panels must be bonded within that period, in order to guarantee the maximum adhesion of the adhesive. This manufacturer-dependent time span can vary from 8 hours to 20 days.
- Depending on the admissible open time (activation period), the wood can be treated with the primer in the workshop, or sheltered from rain, dust and wind.
- Before bonding on site, dust off the wooden battening.
- The MEG panels must be dusted, cleaned and degreased before being glued.
- With some glue manufacturers the panels also must be sanded and/or pre-treated.
- Lay a double-sided neoprene foam tape approximately 3 mm thick and 10 mm wide onto the wooden battening. Along the line of joint, the neoprene tape should be laid on the joint side of the wooden batten, in order to avoid visible glue residues in the joint. This tape has two purposes: first, it holds the panel in place until the adhesive reaches its full bonding capacity and secondly, the thickness of the tape will give the glue an appropriate mass and guarantee an adequate, flexible bond.
- Alongside the neoprene tape, lay a continuous, pyramid-shaped trail of glue about 8 mm wide and 10 mm high using a glue gun with a nozzle designed specifically for this purpose.
- Now press the MEG panel down onto the tape and adhesive. Note: the panel should be placed/positioned carefully and in the correct position. It is advisable to create a stable, accurate base with the first row of panels. For the panels placed subsequently, use the first row of panels on which small spacer pieces are placed along the line of the joint. Panel offcuts can be used as spacer pieces, since their thickness could correspond with the joint width employed.

Horizontal section

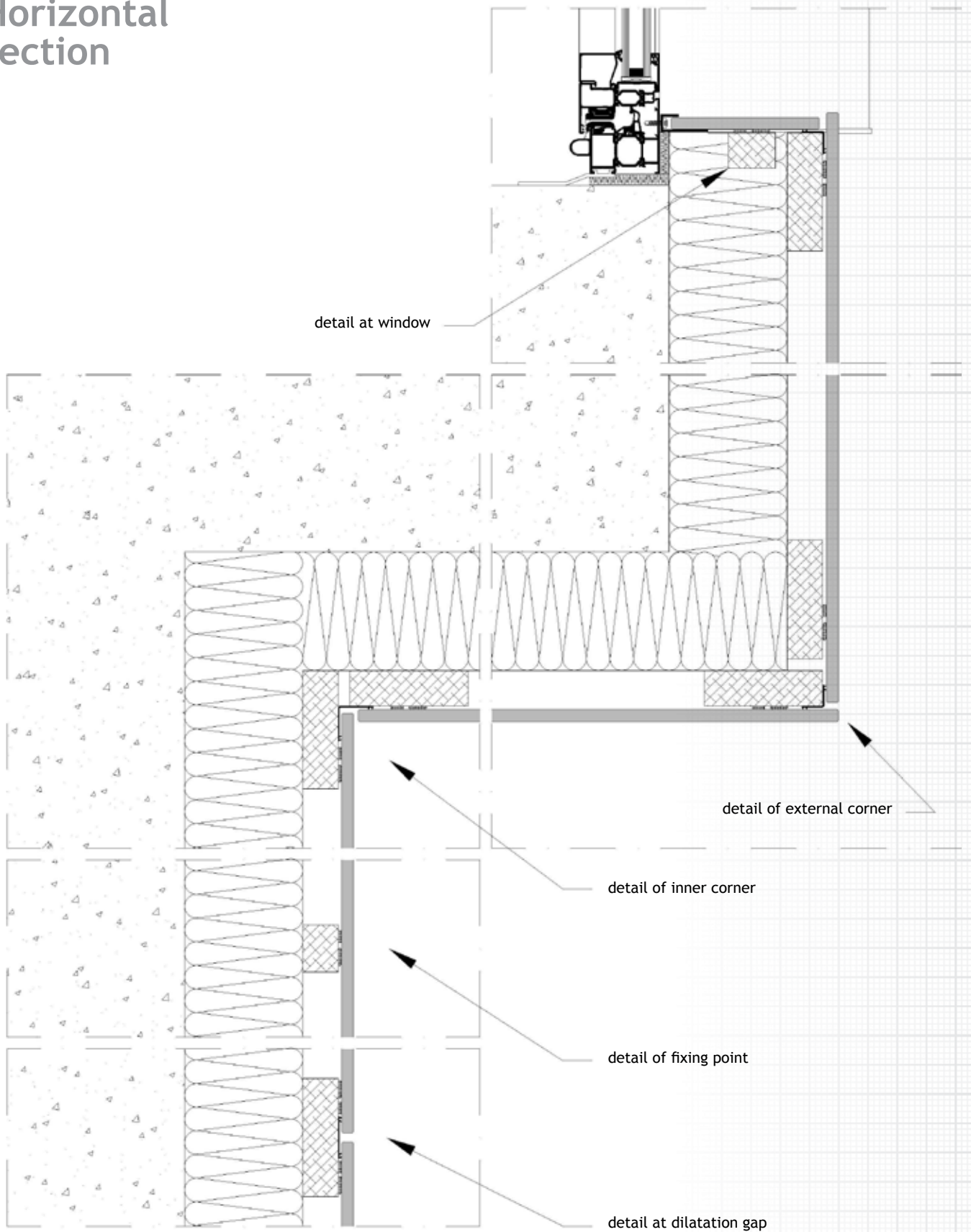



MATERIAL EXTERIOR GRADE

Vertical section

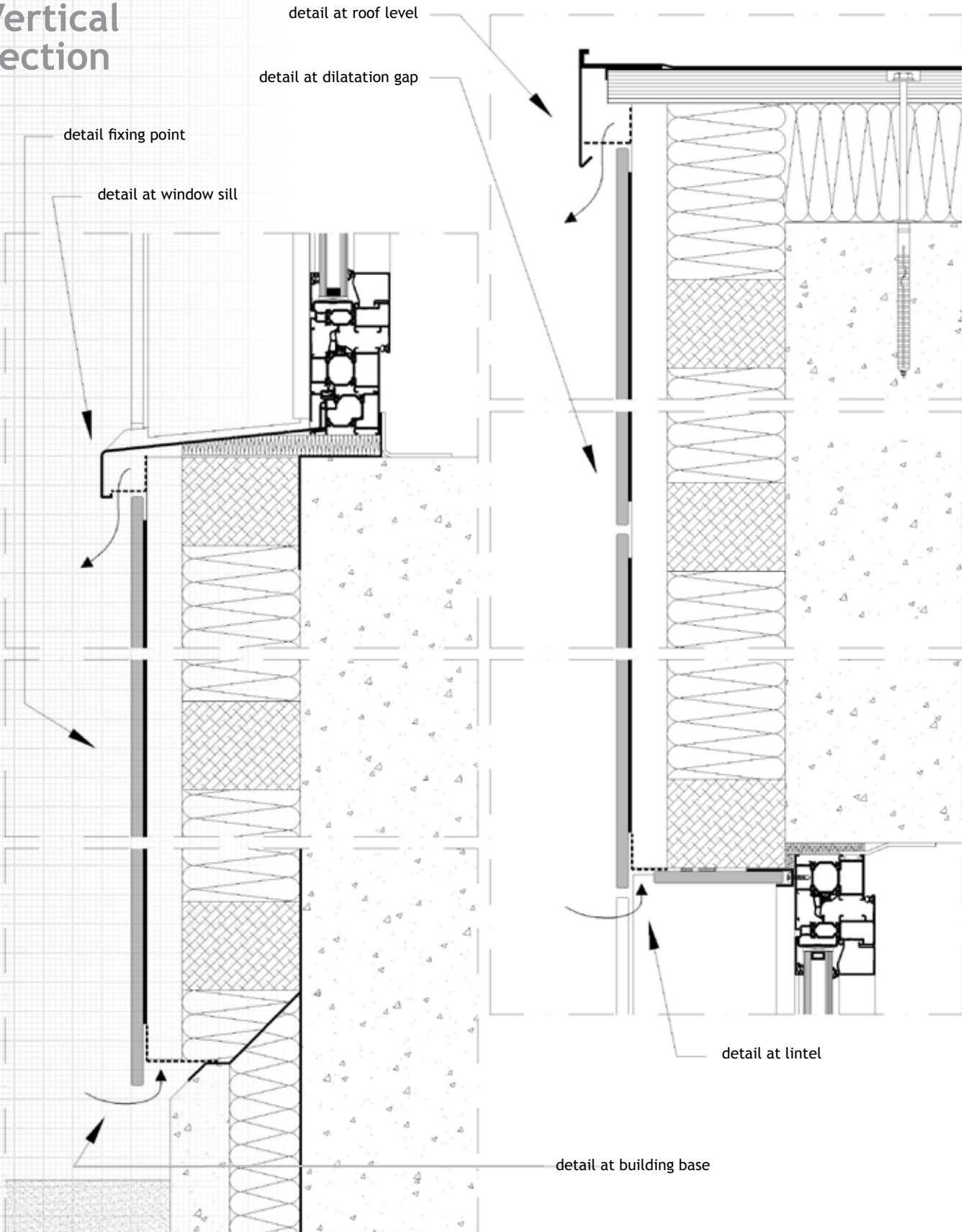

6.5.3.3. Gluing on aluminium substructure

- MEG panels can be bonded with a flexible MS polymer or polyurethane adhesive system for façade cladding. Please note that processing times, open times, minimum and maximum application temperatures and application methods do vary depending on the adhesive manufacturer. Please consult the adhesive manufacturer's processing guidelines.
- When gluing MEG always use a single-sided decorative MEG panel with a backing reference on the reverse side of the panel. Always glue on the backing side of the MEG panel. Contact your local Abet Laminati representative for the up-to-date list of concerned MEG Standard decors.
- A maximum panel dimension has to be respected in conformity with the tolerated panel dilation depending on the flexibility and strength of the glue. Refer to the glue manufacturer for the maximum authorised diagonal dimension of the panel.
- Before bonding on site, dust, clean and degrease the aluminium support structure.
- The MEG panels must be dusted, cleaned and degreased before being glued.
- With some glue manufacturers the panels also must be sanded and/or pre-treated.
- Lay a double-sided neoprene foam tape approximately 3 mm thick and 10 mm wide onto the aluminium battening. Along the line of a joint, the neoprene tape should be laid on the joint side of the aluminium batten, in order to avoid visible glue residues in the joint. This tape has two purposes: first, it holds the panel in place until the adhesive reaches its full bonding capacity and secondly, the thickness of the tape will give the glue an appropriate mass and guarantee an adequate, flexible bond.
- Alongside the neoprene tape, lay a continuous, pyramid-shaped trail of glue about 8 mm wide and 10 mm high using a glue gun with a nozzle designed specifically for this purpose.
- Now press the MEG panel down onto the tape and adhesive.
Note: the panel should be placed/positioned carefully and in the correct position. It is advisable to create a stable, accurate base with the first row of panels. For the panels placed subsequently, use the first row of panels on which small spacer pieces are placed along the line of the joint. Panel offcuts can be used as spacer pieces, since their thickness could correspond with the joint width employed.
- When bonding onto aluminium battening, allow for the expansion of the aluminium. If an expansion joint is created in the aluminium structure, also ensure that the panels are interrupted in this place using an expansion joint.



MATERIAL EXTERIOR GRADE

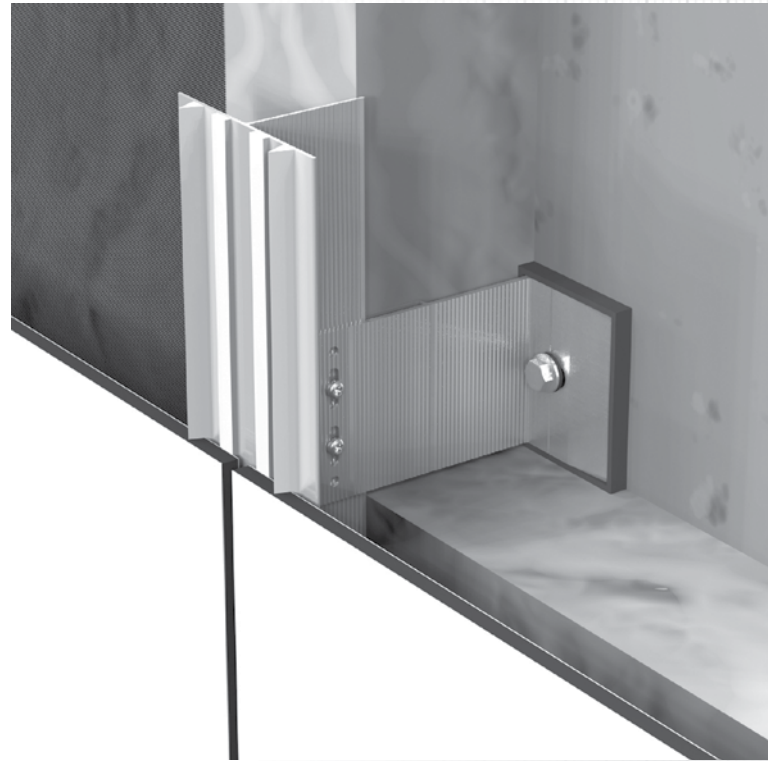



MATERIAL EXTERIOR GRADE

Horizontal section

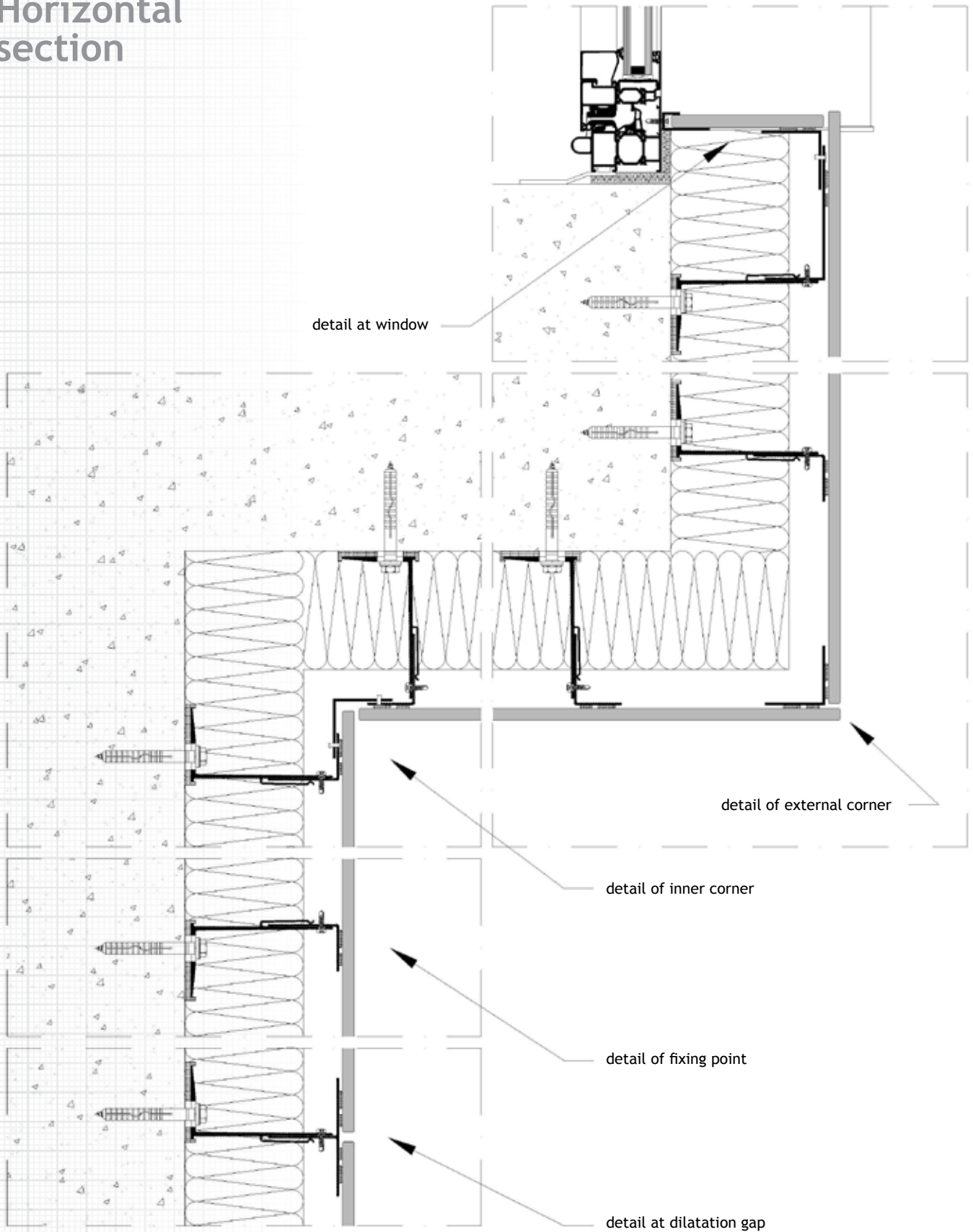

Vertical section

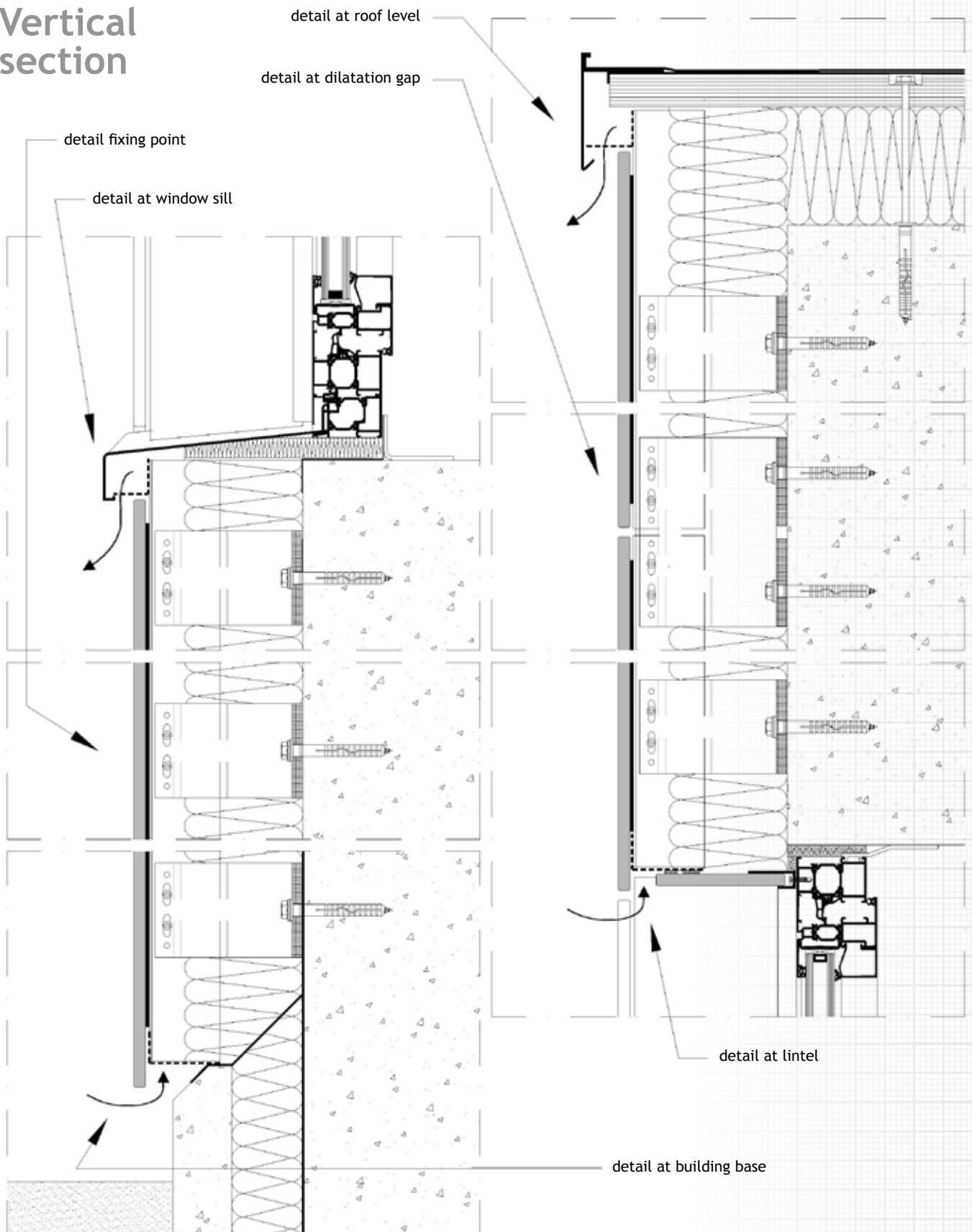



6.5.3.4. Invisible fixing with overlapping panel strips (weatherboarding or lap siding)

- MEG panels with a panel thickness of 8 mm can be laid as overlapping panel strips, using a specially designed stainless steel fixing clip.

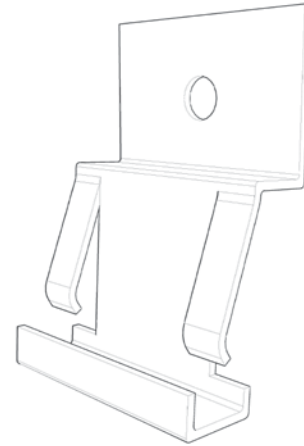

- The height of the MEG panel strips may not exceed 350 mm and the overlap is 25 mm.
- A groove is created on the bottom of the MEG panel strips in order to fix the strip to a wooden subconstruction.

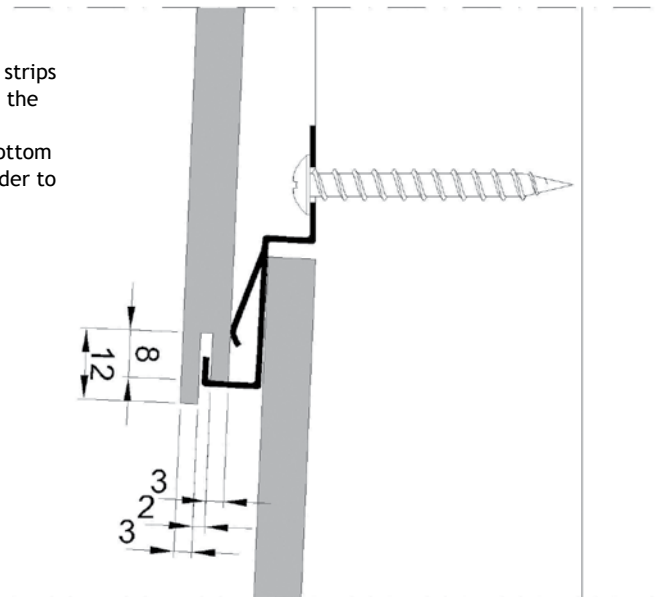

- The maximum centre-to-centre distance of the wooden battening may not exceed 600 mm. The width of the battening at a joint should be at least 75 mm; for the other vertical battens a width of 40 mm is sufficient. A fixing clip is placed on each vertical batten.
- The MEG panel strips should be laid working from the bottom upwards. A small adjuster block should be fitted below the fixing clips on the bottom row. The top row is screwed to the battening through a pre-drilled hole, eventually also with an underlying adjuster block if the top panel strip is smaller than the others.
- All MEG panel strips should be fixed in the middle at the top of the strip (fixed point) in order to prevent the strips displacing.
- The maximum allowed length of the strips is 3.03 m

Horizontal section

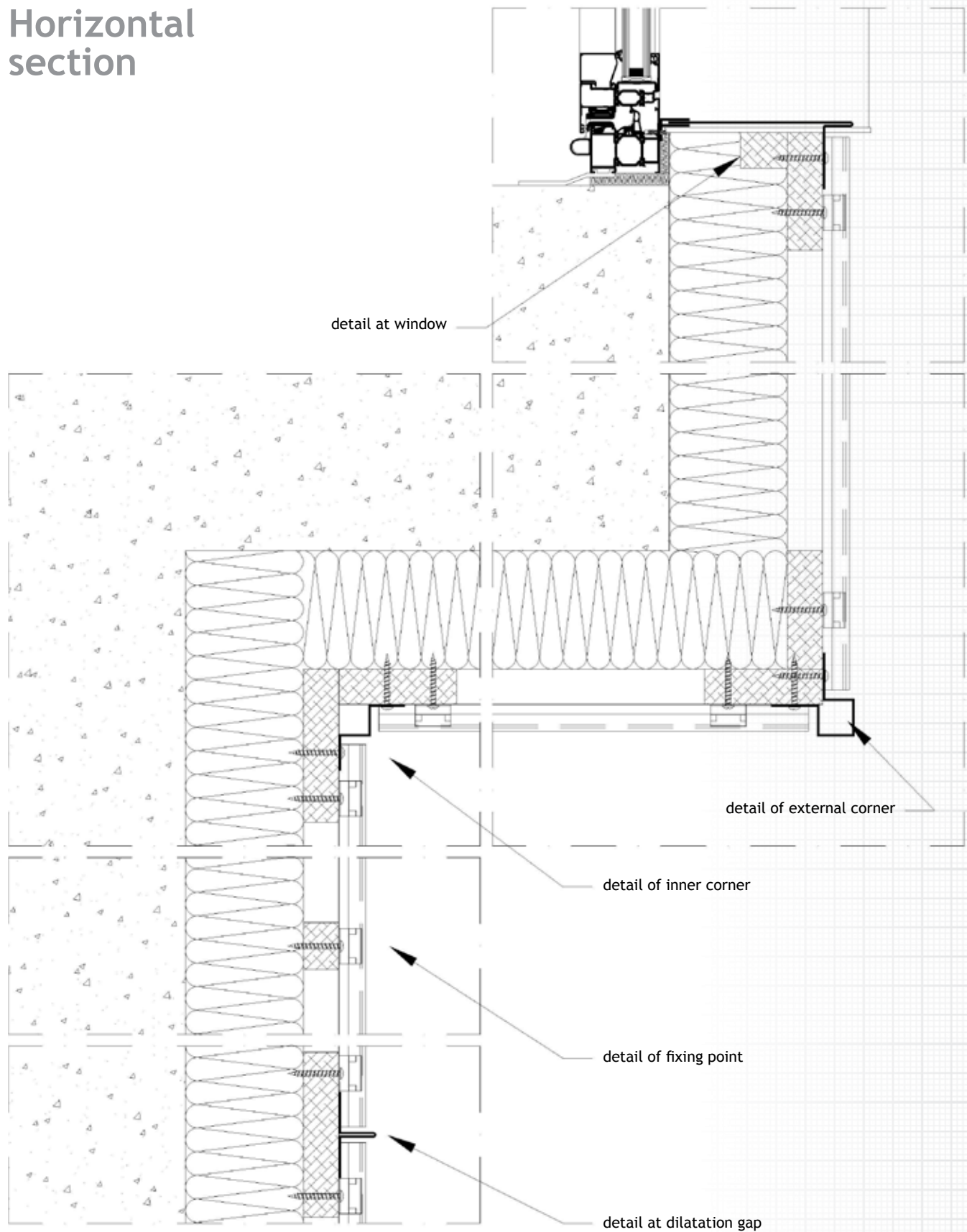



MATERIAL EXTERIOR GRADE

Vertical section

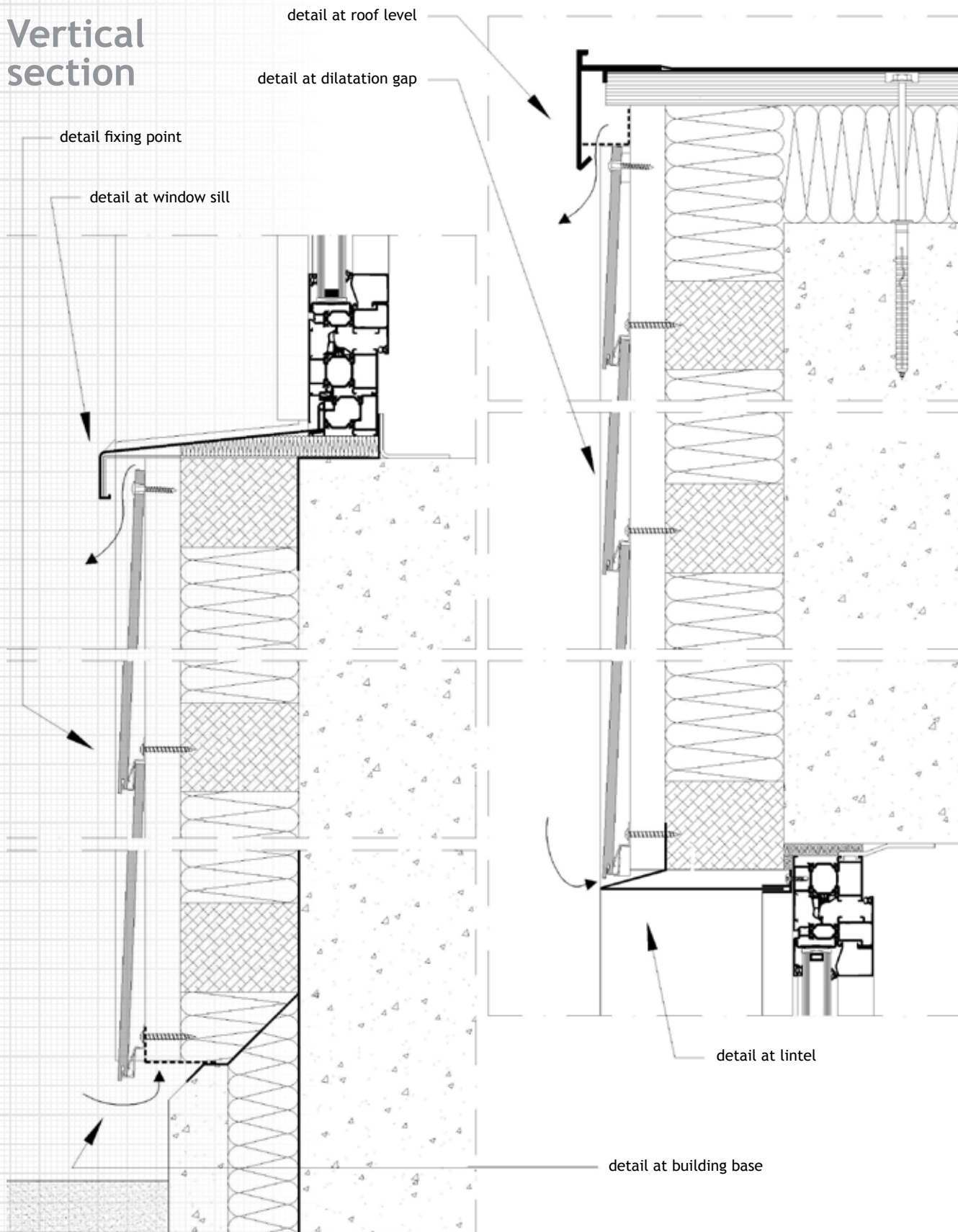

6.5.3.5. Invisible fixing with profiled edged panels in horizontal running aluminium hook profile

- From panel thickness 8 mm upward, MEG panels can be blind-fixed using horizontal running aluminium hook profiles fixed on a wooden or aluminium subconstruction.
- This type of fixing is ideal for long sized horizontal panel layout.
- This fixing method is only for one span panel fixing. Accordingly to this the panel height may not exceed:
 - 500 mm for a 8 mm panel
 - 600 mm for a 10 mm panel
 - 700 mm for a 12 mm panel
- A fixing point should be realized by application of a MS Polymer glue strip of 50 to 100 mm in the groove at the centre of the underside of the MEG panel.

- Panel profile dimensions:

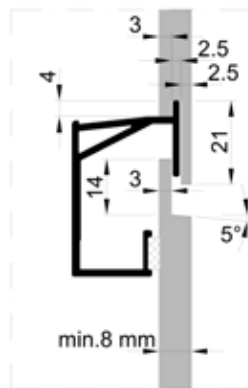

- The vertical dilation gap can be realised as:

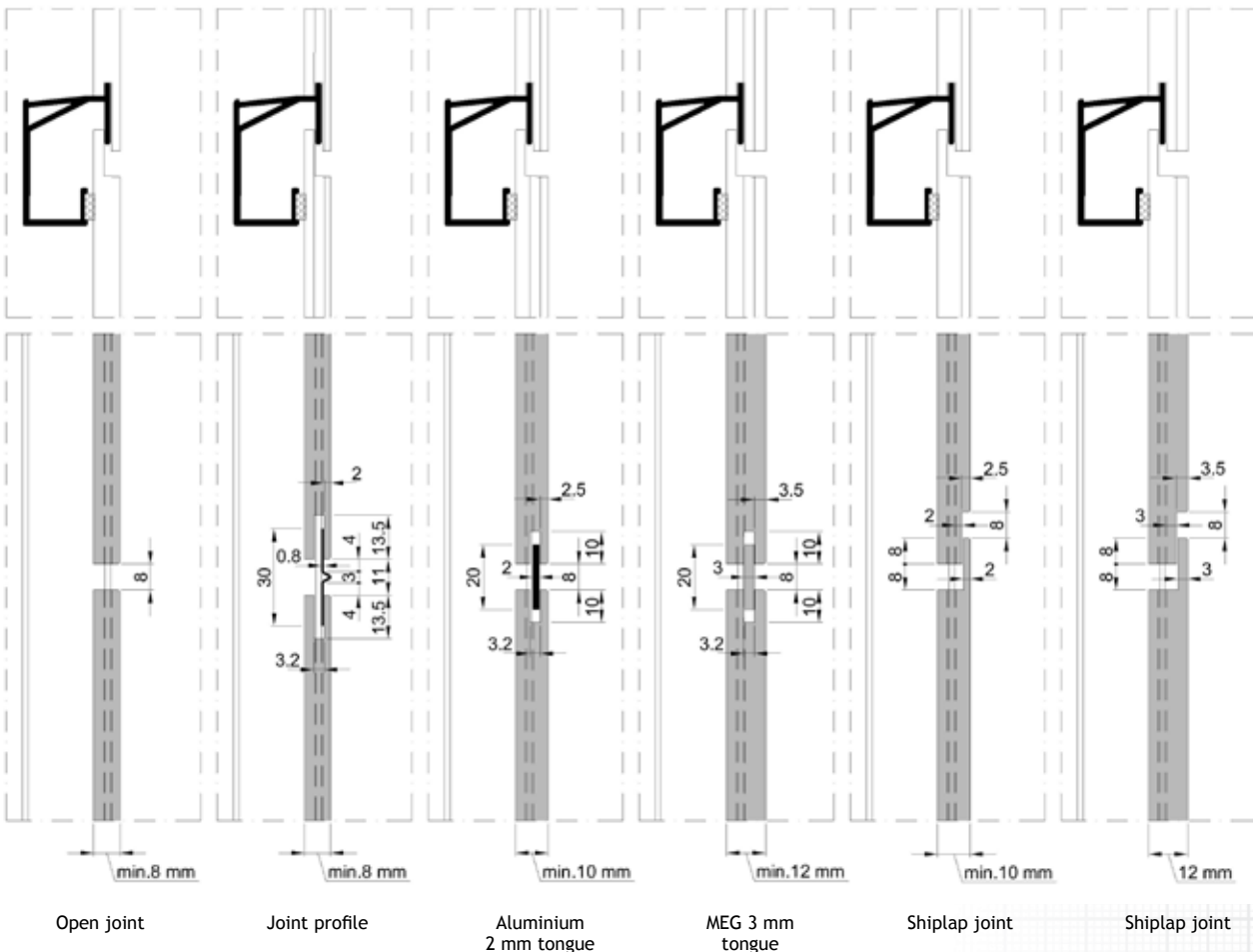



MATERIAL EXTERIOR GRADE

Horizontal section

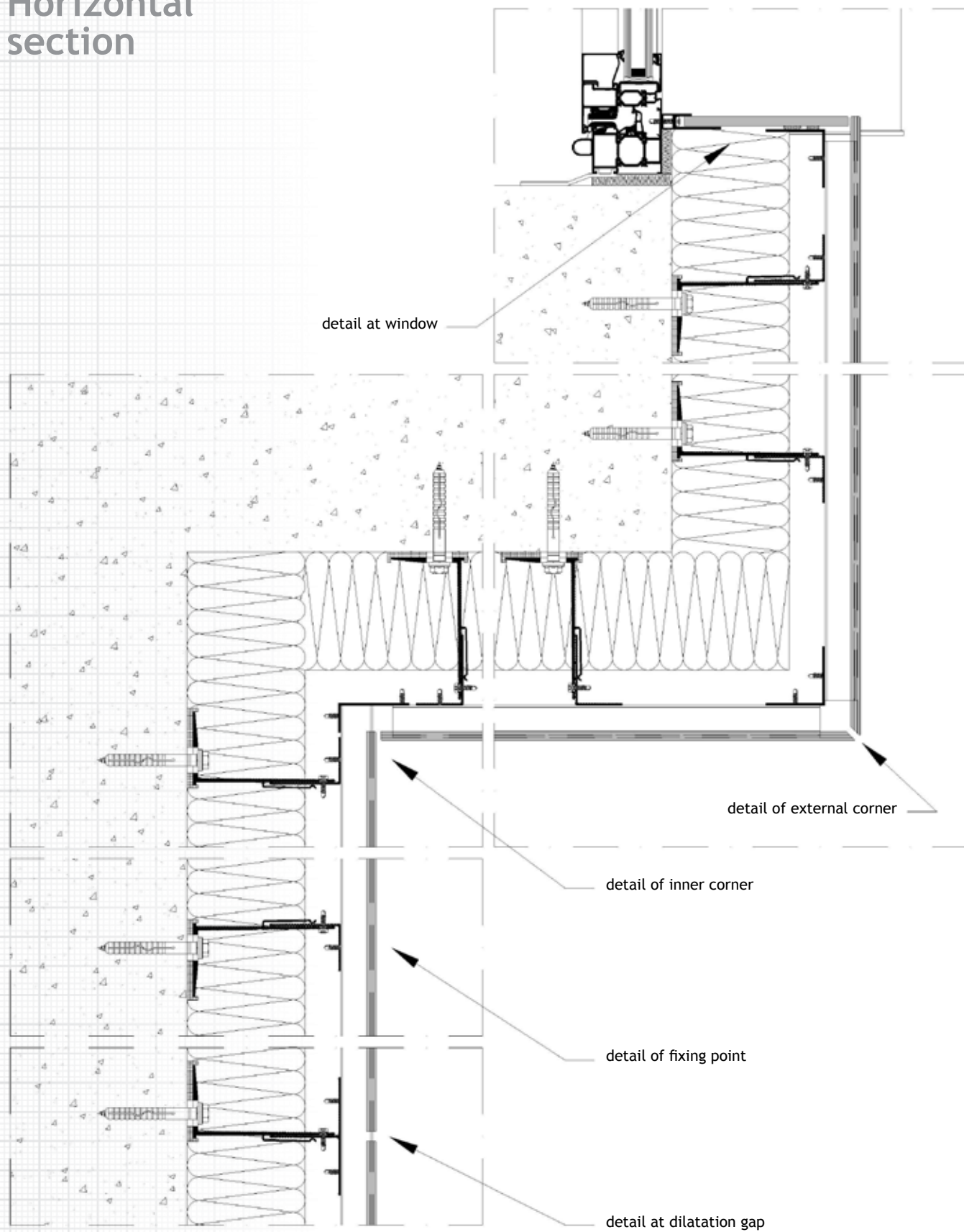

Vertical section

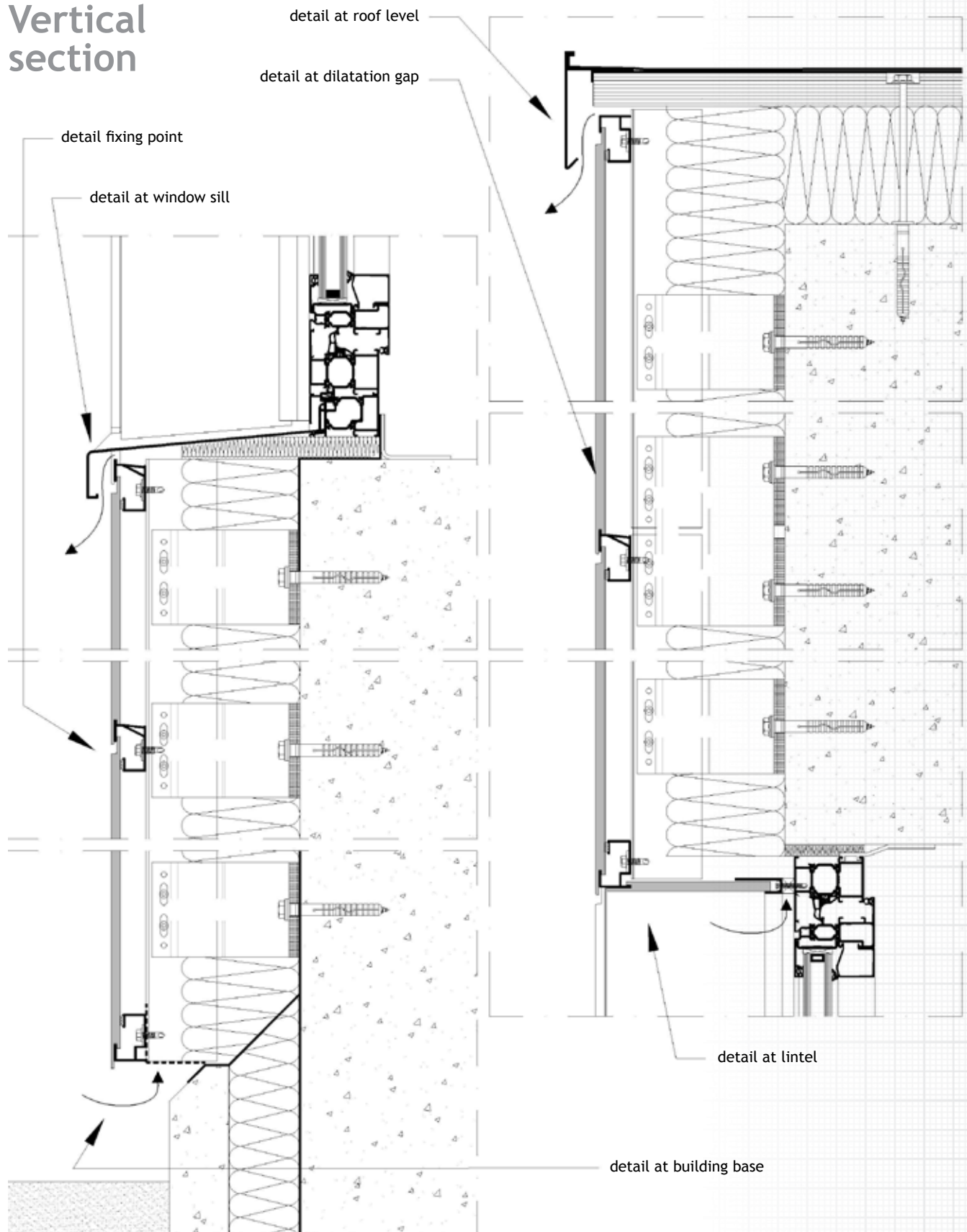



MATERIAL EXTERIOR GRADE

6.5.3.6. Invisible fixing with panel hooks (anchors) on aluminium horizontal running hook profile with aluminium subconstruction

- It's important to measure the hooking depth of the proposed system and to compare it with the possible dilatation and/or shrinkage of the panel in order to avoid the panel to hook off the horizontal running hook profile.
- Abet Laminati advises to use double slot anchors with adapted hook profiles, since single slot systems could block the dilatation of the panels if some moment of forces would occur on the hook.



- From panel thickness 10 mm upward, MEG panels can be blind-fixed using aluminium panel hooks (anchors). These are secured to the rear of the panels with self-tapping screws (Ejot or Taptite) or ordinary screws combined with expander plugs (inserts). Always use Stainless steel fixing devices. For Ejot and Taptite screws the drilling diameter should be 4.9 mm. For expander plugs it depends on the plug diameter.

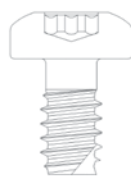

Ejot Duro PT-S 60

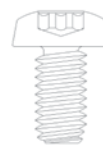

Taptite

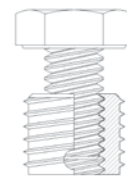

Expander plug + screw

- It is also possible to blind-fix MEG panels from a thickness of 8 mm on, but only using special undercut expander plugs (Keil or Fisher) or special blind rivet fasteners (SFS Intec).

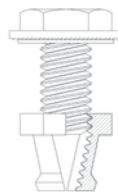

Keil undercut anchor



Fisher undercut anchor



SFS Intec blind rivet fastener TU-S



MATERIAL EXTERIOR GRADE

- In general an absolute minimum residual thickness of 2 mm MEG material must be left, when drilling for the fixing.
- The fixing device may never touch the bottom of the predrilled hole. Depending on the type of drilling tool, a tolerance should be observed of minimum 1 mm between the bottom of the hole and the top of the fixing device when inserted, taking in account the thickness of the panel hook. Only for the Fisher and Keil undercut anchors this point of attention is not applicable since you need to realise a special undercut hole with a special undercut drilling tool. In this case the very small tolerances are indicated by the fixing device manufacturer.
- The panel hooks should be positioned according to the anchoring plan (see p.15).
- The middlemost panel hook (fixed point) must be secured at the top of the panel. The panel hooks to the left and right of this are set points (support points). All panel hooks below this must be positioned in such a way that they can slide freely up and down (expansion). They are so called sliding points. They should therefore be positioned slightly higher.
- With this fixing method it is not possible to add a joint finishing profile for the horizontal joints. The vertical joints also remain open.
- If closed joints are desired with this fixing method, it can only be achieved by using the shiplap method, but then two open square holes will be visible. In order to avoid this holes it is possible to combine the shiplap method for the horizontal joints with a vertical spring made of 3 mm phenolic panel, suitable for exterior applications (in order to have the same colour between the milled panels and the spring), set in a vertical groove milled for the purpose.

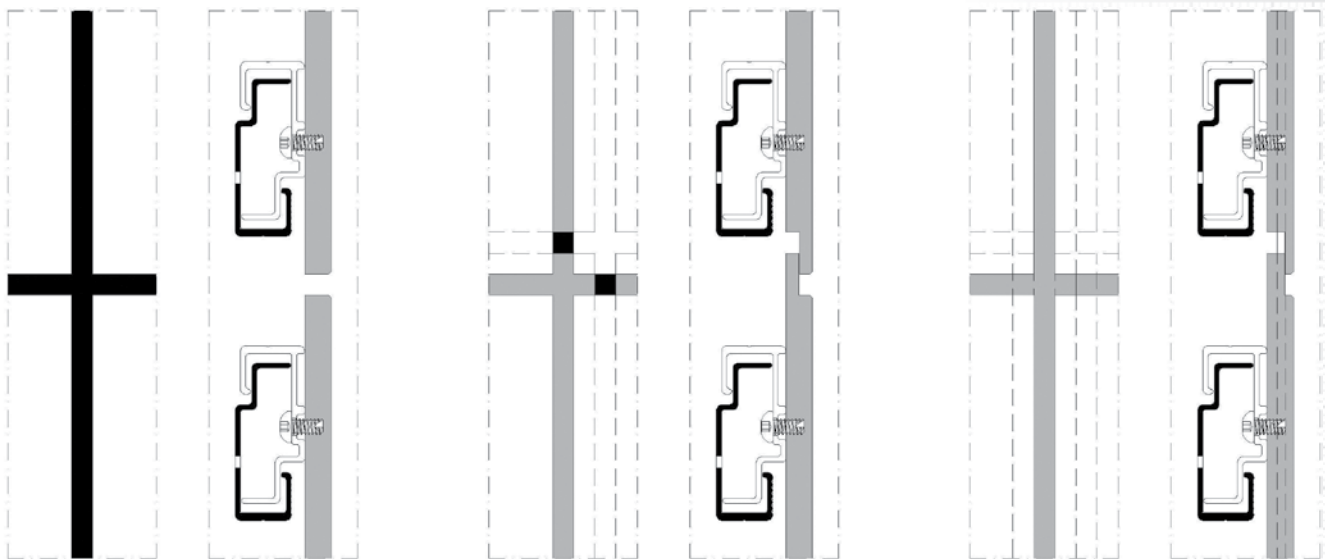

Open joint

Shiplap joint

Shiplap-spring joint



MATERIAL EXTERIOR GRADE

Horizontal section

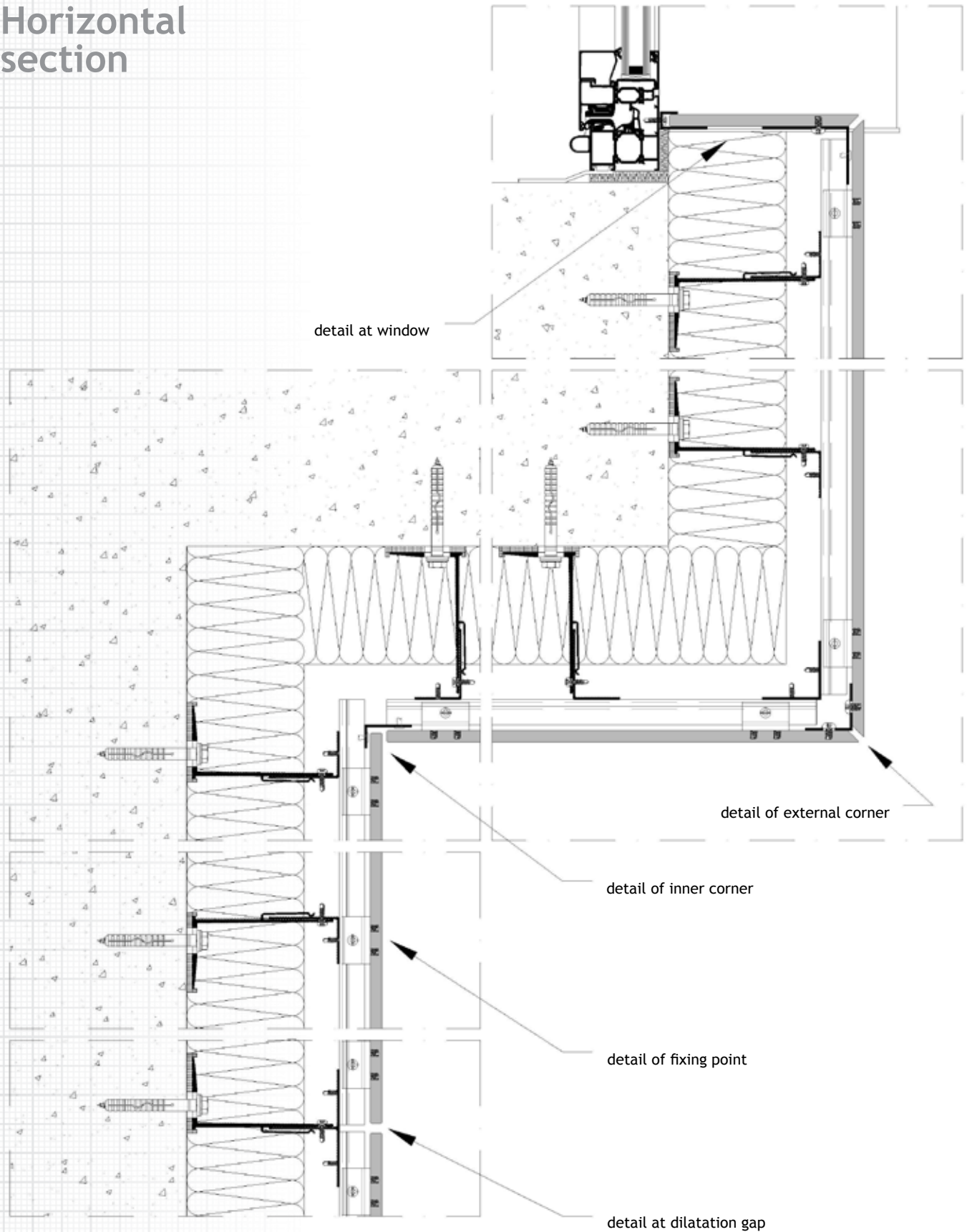

Vertical section





MATERIAL EXTERIOR GRADE

6.5.3.7. Sandwich panel in profile system

- MEG panels are available in panel thicknesses of 2, 2.5 and 3 mm with a sanded back in order to be glued onto a insulation core (e.g.: PU core): the component thus obtained is an insulating sandwich panel.
- These sandwich panels can be used in wood, PVC or aluminium profiles.
- A clearance should always be allowed between the sandwich panel and the profiles bottoms (about 4 mm on three sides).
- The sandwich panel is best laid on support blocks.
- Always allow for water drainage of the bottom batten.
- The sandwich panel should be connected to the profile with durable, solid glazing rubbers. Joint sealants are not advisable because of the potential expansion of the panels: over time sealants tend to break down.

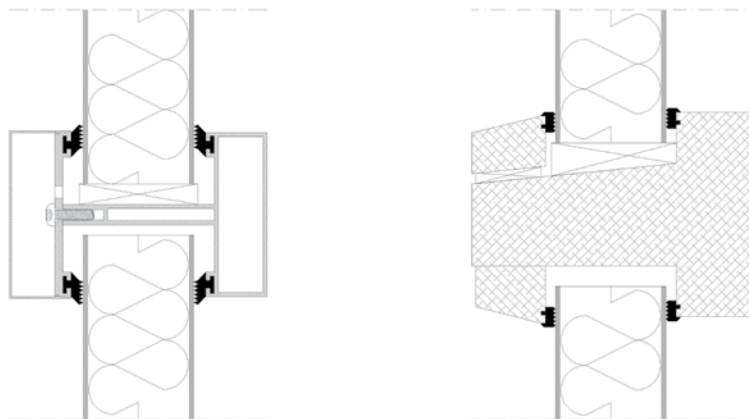

6.5.4. Special fixings

6.5.4.1. Canopy cladding

The underside of overhanging horizontal building elements can also be clad with MEG panels.

- Both the visible and invisible mechanical fixing methods may be used, except for the weatherboarding technique and the profiled panel edge method, which are only suitable for vertical applications.
- All placement guidelines already described must likewise be observed for horizontal applications.
- If the panels are fixed with panel hooks on an aluminium structure, secure each panel by screwing the panel hook securely to the structure in at least one place (fixed point).
- In order to allow a natural airflow between the "warm" side of the building structure and the "cold" exterior, the bearing sub-construction should be fixed perpendicular to the façade.
- All centre-to-centre fixing distances should be reduced for horizontal applications. In general we can say that the centre-to-centre distance should be reduced by 20% of the dimensions given into the "fixing plan" tables (p.15).
- Fixing the panels by using the bonding technique is also possible. It is appropriate to lock each panel in at least one place (centrally) by mechanically fixing the panel to the sub-structure.
- In case of bonding the centre-to-centre distance should be reduced by an additional 20%. This means that the dimensions given into the "fixing plan" tables (p.15) will be reduced by 36%.
- Always take into account the regional legislation concerning horizontal applications of cladding especially according to the regional fire regulations.

6.5.4.2. Curved cladding

Curved architectural elements can also be clad with MEG panels. Panel thicknesses of 4, 6 and 8 mm are used for this.

- If necessary, panels with a thickness of 4 mm may be glued with an MS polymer adhesive. For this the panels should be kept clamped during the glue polymerisation process, without nipping the glue strip flat. You should always observe a glue thickness of 3 mm. For this kind of application, it is advisable to conduct a preliminary study and build a trial element. For safety reasons, Abet Laminati considers it necessary to lock curved panels mechanically at the extremities.
- For a visible, screwed or riveted mechanical fixing, 4, 6 and 8 mm panels may be used.
- The minimum radii are:

| Thickness mm | MIN R mm | MIN L mm |
|--------------|----------|----------|
| 4 | 2000 | 1000 |
| 6 | 3000 | 1500 |
| 8 | 5000 | 2000 |

• The fixing distances :

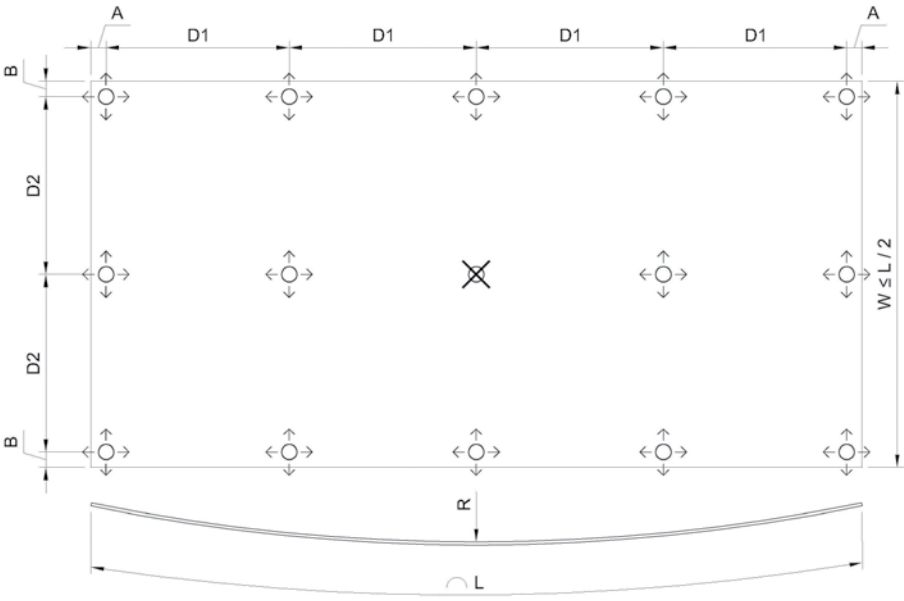

| Thickness mm | MAX D1 mm | MAX D2 mm | A mm | B mm |
|--------------|-----------|-----------|-------|-------|
| 4 | 400 | 400 | 20-40 | 20-40 |
| 6 | 500 | 500 | 20-40 | 20-40 |
| 8 | 600 | 600 | 20-40 | 20-40 |

6.5.4.3. Perforated cladding

- Depending on the application panel thickness from 8 mm up could be used.
- Be aware that the panel are weakened with perforations, and even weaker with limited thicknesses.
- Never remove more than 50% of the panel.
- Between the perforations always provide a minimum space equal to the opening or diameter of the perforation (A). It also applies to edge distances.
- For grooves always use a maximum length equal to the span distance “X” between fixing points (see p.15) minus 10%.
(In other words: the maximum length of the grooves equals 0.9X)
- The width of the groove may not exceed 2 times the panel thickness (t).
- Observe a distance between the grooves equal to 4 times the panel thickness (t).
- Observe a distance between the grooves in their prolongation equal to 8 times the thickness of the panel (t).
- Observe a distance between the 1st groove and the parallel edge of the panel equal to 8 times the panel thickness (t).
- It is always preferable to realise a mock-up in order to check the stiffness and strength of the panel with the fixation.
- Always respect the local regulation about openings in claddings especially to wind loads, fire regulation and children safety.

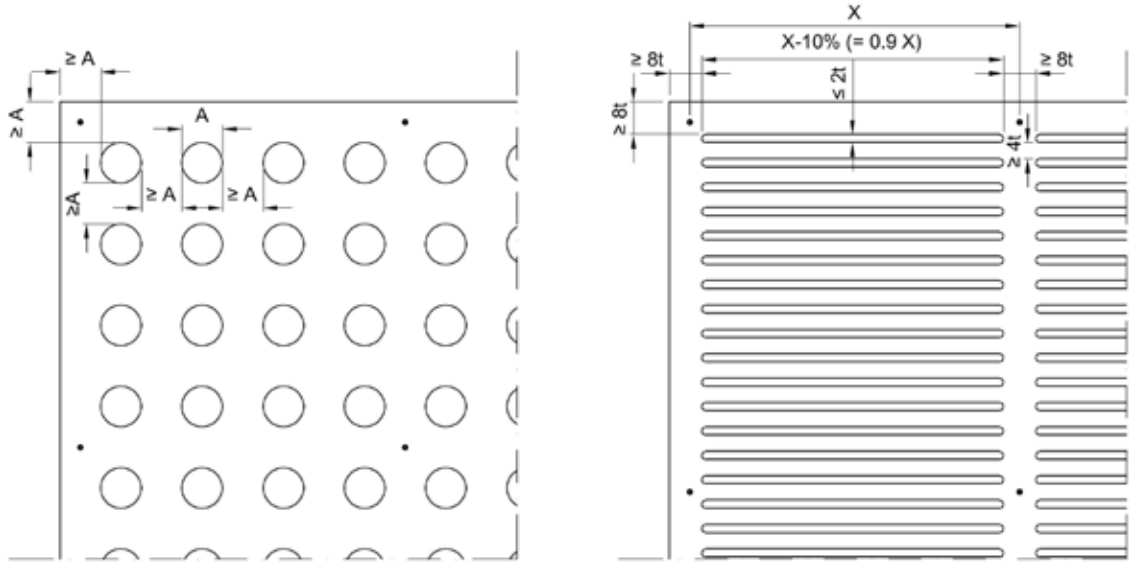



MATERIAL EXTERIOR GRADE

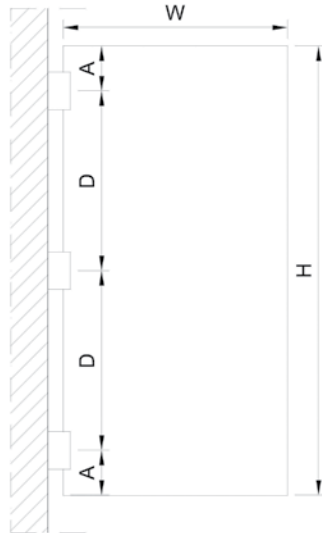

6.5.4.4. Shutters

- Shutters could be realised as free standing elements or supported by frames.
- Shutters could be fixed with hinges (always provide minimum 3 hinges) or sliding on rails.
- Always provide enough ventilation on both sides of the MEG panels, in open as well in closed position.
- Shutters as free standing elements, fixed with hinges, have a maximum width (W):

| Panel Thickness (mm) | Width (W) (mm) | D (mm) | A (mm) |
|----------------------|----------------|--------|--------|
| 10 | 450 | 450 | 80 |
| 12 | 525 | 525 | 100 |
| 14 | 600 | 600 | 120 |
| 16 | 675 | 675 | 140 |
| 18 | 750 | 750 | 160 |

- The maximum allowed height (H) of the panel is 3,03 m.
- Be careful to have only 1 fixed point (1 hinge). All the others must be sliding points (sliding hinges).
- When Shutters are supported by frames, fixed with hinges or sliding on rails, it is important to respect the span distances (p.15) for the frame construction.
- If frames are used, they have to be made out of a material that doesn't corrode (or must be treated against corrosion) and that isn't corrosive.
- Frames must be realised as a rigid construction able to stand by their own and solid enough to support some tensions and wind loads.
- The MEG panel may not be used as a structural element of the construction.
- If MEG panels are clamped into a frame profile always provide enough dilatation possibility between the edge of the MEG panel and the bottom of the profile on 3 sides of the frame. Close the opening between the frame and the MEG panel with UV resistant EPDM joint profile.
- Provide drainage at the lowest part of the frame in order to avoid having standing water on the edge of the MEG panel. For this purpose, it is best to put the MEG panel on spacers of about 5 mm.

6.5.4.5. Sun screens

- Sun screens will always be supported by a frame.
- For sun screens use MEG of 8 mm and upwards.
- The frame must be realised in a material that doesn't corrode (or must be treated against corrosion) and that isn't corrosive.
- The MEG sun blinds lamella must be at least 100 mm wide.
- Always provide minimum 2 fixing points in the width of the MEG lamella.
- Always provide minimum 3 fixing points in the length of the lamella.
- Use always visible or secret mechanical fixing (no gluing).
- For each lamella, only 1 fixed point must be provided at the centre of the lamella. All other fixing point should be sliding points in order to allow dilatation.
- Always provide a dilatation gap between lamellas in the same line and also between lamellas and obstacles.

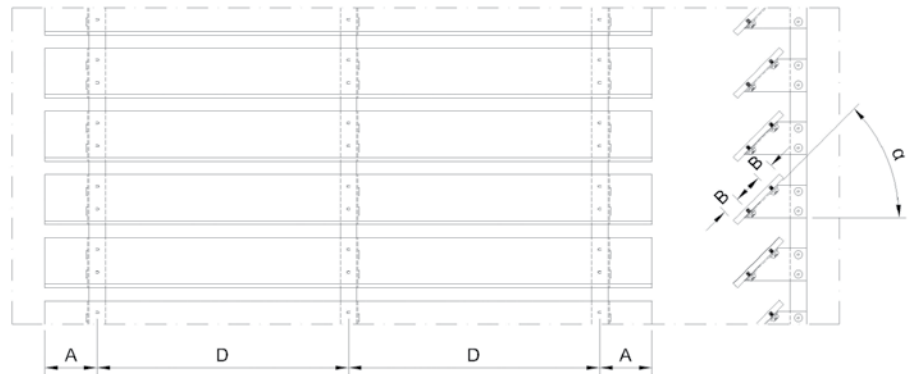

| Panel Thickness mm | MAX D $\alpha \geq 45^\circ$ mm | MAX D $30^\circ < \alpha < 45^\circ$ mm | A mm | B mm |
|--------------------|---------------------------------|---|--------|-----------|
| 8 | 600 | 500 | 20-60 | ≥ 20 |
| 10 | 750 | 650 | 20-80 | ≥ 20 |
| 12 | 900 | 800 | 20-100 | ≥ 20 |

7. Parapets and balustrades

7.1. General guidelines

- When using MEG for balustrades, local technical legislation must be respected for heights admissible openings and fixings.
- Local regulations and technical standards must also be observed in respect of stability, strength, and stiffness for all structural components of the balustrade structure.
- Fixing distances and systems advised by Abet Laminati takes in consideration the stability of the MEG panels only. The number of type of fixation has to be determined and calculated by an independent construction engineering office.
- The installation instructions of the supplier of the balustrade structure should be respected. If they conflict with the installation guidelines of Abet Laminati, please consult the relevant parties.
- A minimum expansion of 1.5 mm/m should be allowed for at the fixing points and/or clamps.
- The fixing of MEG panels must in all circumstances allow expansion and contraction of the panels.

7.2. Fixing principles

7.2.1. Types of fixing

- Fixing with aluminium/stainless steel blind rivets
 - Can be used from sheet thickness 8 mm upward.
 - Are available from specialist dealers with an optionally painted head.
 - Respect the length of the rivet advised by the supplier of the rivet taking in account the sum of the different material thicknesses to be joined.
 - The blind rivets used must have a minimum diameter of 5 mm and a large head of 16 mm diameter. Respect the fixed and expansion point principle.
 - The diameter of the hole in the MEG panel for a fixed point fixing must be 5.1 mm when the shaft diameter of the rivet is 5 mm.
 - The diameter of the hole in the MEG panel for an expansion point must be 10 mm when the shaft diameter of the rivet is 5 mm and the head diameter is 16 mm.
 - If using other dimensions of rivets, reconsider the diameters of the respective holes, taking in account the dilatation of the MEG panels and the adapted head diameter of the rivet.
 - Use a template for centring the drilled hole in the underlying structure in relation to the hole in the MEG panel.
 - Use a suitable riveter head that will allow a clearance (+0.3 mm) at an expansion point.
 - For more information, always consult the assembly instructions of the supplier of the fixing materials.
- Fixing with balcony bolts
 - Can be used from sheet thickness 8 mm upward.
 - Are available from specialist retailers with optionally painted flat head or can be supplied with plastic washer and cover.
 - The screw should always be 10 mm longer than the sum of the different thicknesses of material to be joined.
 - The screws used should be minimum M6.
 - The diameter of the hole in the MEG panel for a fixed point fixing should be 6 mm.
 - The diameter of the hole in the MEG panel for an expansion point must be 10 mm.
 - Use a template for centring the drilled hole in the underlying fixing structure in relation to the hole in the MEG panel.
 - The bolts should have a broad, flat head (min 16 mm).
 - 1-span fixing distances for rivet or bolt fixing:

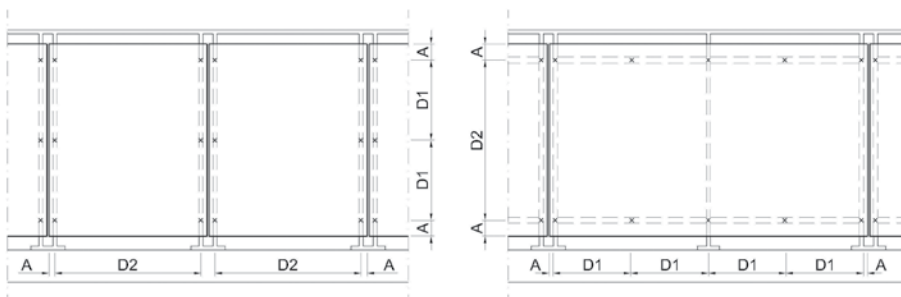

| Panel Thickness | Type of Fixing | Distance D1 mm | Distance D2 mm | Distance A mm |
|-----------------|----------------|----------------|----------------|---------------|
| 8 | Rivet | 500 | 600 | 20 - 60 |
| | Bolt | 600 | 600 | 20 - 60 |
| 10 | Rivet | 500 | 750 | 20 - 80 |
| | Bolt | 700 | 750 | 20 - 80 |
| 12 | Rivet | 500 | 900 | 20 - 100 |
| | Bolt | 800 | 900 | 20 - 100 |
| 14 | Rivet | 500 | 1050 | 20 - 120 |
| | Bolt | 900 | 1050 | 20 - 120 |



MATERIAL EXTERIOR GRADE

- 2 or more span fixing distances for rivet or bolt fixing:

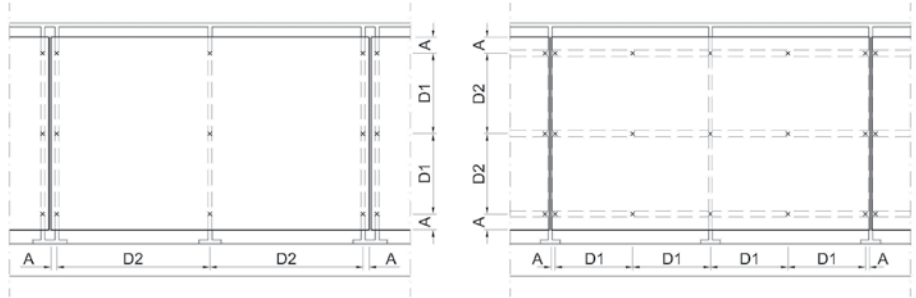

| Panel Thickness | Type of Fixing | Distance D1 mm | Distance D2 mm | Distance A mm |
|-----------------|----------------|----------------|----------------|---------------|
| 8 | Rivet | 500 | 650 | 20 - 60 |
| | Bolt | 700 | 650 | 20 - 60 |
| 10 | Rivet | 500 | 800 | 20 - 80 |
| | Bolt | 800 | 800 | 20 - 80 |
| 12 | Rivet | 500 | 950 | 20 - 100 |
| | Bolt | 900 | 950 | 20 - 100 |
| 14 | Rivet | 500 | 1100 | 20 - 120 |
| | Bolt | 1000 | 1100 | 20 - 120 |

- Fixing with panel clamps
 - Can be used from sheet thickness 8 mm upward.
 - Panel clamps are fixed to the balcony structure.
 - It is advisable to use panel clamps with a locking pin, so that the panel is held in place in case the clamp loosens.
 - Provide only one fixed point per panel.
 - Ensure that there is enough space for the expansion near the locking safety pin of the panel clamp.
 - Provide enough space for dilatation between the panel and the clamp bottom.
 - An expansion of 1.5 mm/m should be allowed in all directions.
 - Expansion must also be provided at the safety locking pin.

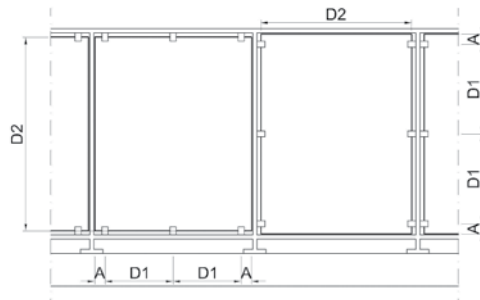

| Panel Thickness | Distance D1 mm | Distance D2 mm | Distance A mm |
|-----------------|----------------|----------------|---------------|
| 8 | 600 | 600 | 20 - 60 |
| 10 | 700 | 750 | 20 - 80 |
| 12 | 800 | 900 | 20 - 100 |
| 14 | 900 | 1050 | 20 - 120 |

- Fixing with horizontal running aluminium edge profile (only for horizontal placed panels)
 - A clearance should always be allowed between the MEG panel and the upper profile bottom (about 4 mm).
 - The profile dimensions and the panel thickness used should be coordinated.
 - Allow for a minimum 16 mm clamping depth of the panels.
 - The MEG panel is best laid on support blocks on the bottom of the lower profile.
 - Always arrange for dewatering (drainage) of the bottom profile. MEG panels must not stay immersed in water for prolonged periods either partially or completely.
 - The MEG panel should be connected to the profile with durable, solid glazing rubbers. Joint sealants are not advisable because the potential expansion of the panels tend to break away sealants over time.

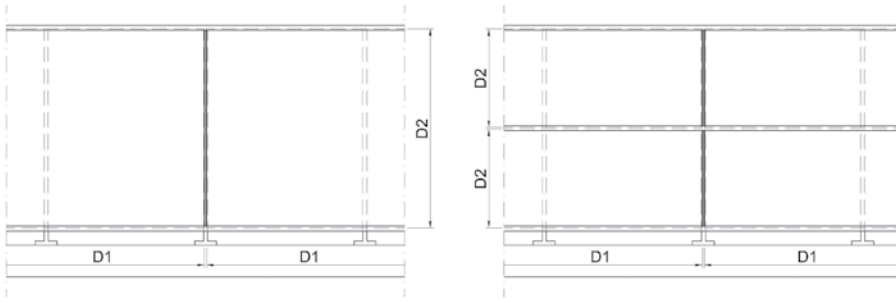

| Panel Thickness mm | Distance D1 mm | Distance D2 mm | Distance A mm |
|--------------------|------------------|----------------|---------------|
| 8 | Max panel length | 600 | 20 - 60 |
| 10 | Max panel length | 750 | 20 - 80 |
| 12 | Max panel length | 900 | 20 - 100 |
| 14 | Max panel length | 1050 | 20 - 120 |

7.2.2. Balcony separations

- Can be used from sheet thickness 8 mm upward.
- Always provide one fixed point (lower internal corner).
- All other fixing point must be dilatation points.
- If the separations are wider, a structure has to be made in order to respect the D1 and D2 distances.
- The structure has to be made out of an corrode free material or has to be treated.
- The structure has to made out of an not corrosive material.

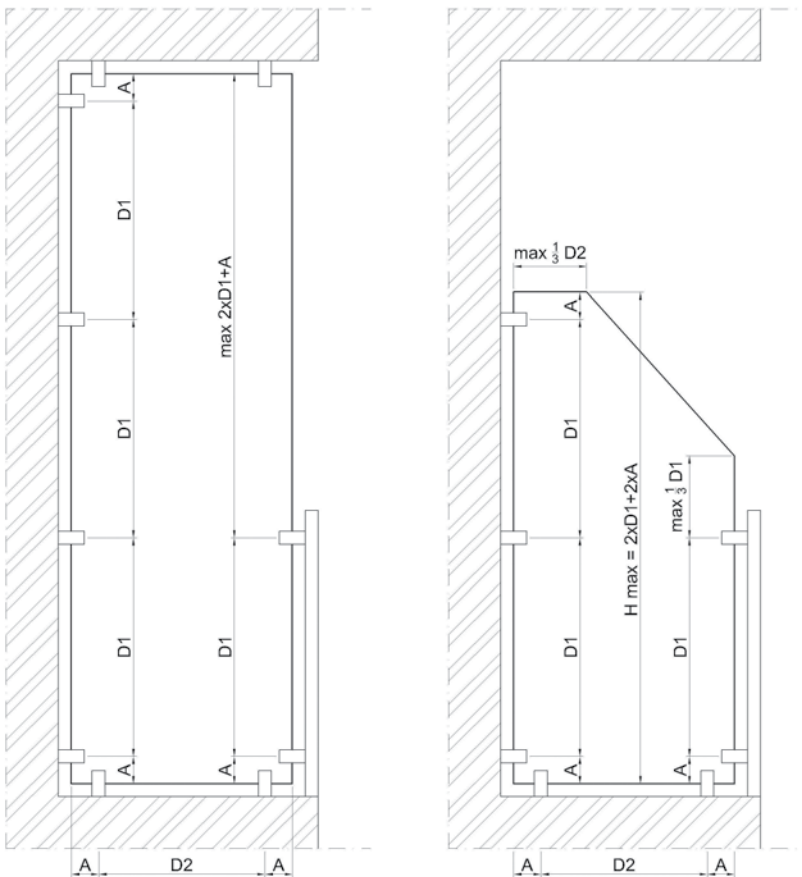

| Panel Thickness | Distance D1 mm | Distance D2 mm | Distance A mm |
|-----------------|----------------|----------------|---------------|
| 8 | 600 | 600 | 20 - 60 |
| 10 | 750 | 700 | 20 - 80 |
| 12 | 900 | 800 | 20 - 100 |
| 14 | 1050 | 900 | 20 - 120 |



MATERIAL EXTERIOR GRADE

8. Maintenance

- MEG panels need little maintenance.
- MEG panels can be cleaned with a mild, non-abrasive detergent dissolved in water using a sponge and/or a soft cloth. After cleaning rinse thoroughly with water. We recommend buffing the panels dry after cleaning, to avoid leaving water marks.
- Avoid excessive rubbing/pressure, or using abrasive materials that could cause abrasion marks or scratches.
- A high pressure cleaner may be used provided that the pressure does not exceed 100 bar and the spray distance is 50 cm. Using a dirt scraper is not advisable.
- MEG's chemical resistant nature and closed structure do not allow paint in spray cans, various inks, emulsion paints, lipstick or pastel paints to adhere to the surface and penetrate to the core. MEG does not require any anti-graffiti treatment.
- If the surface of the MEG is coated with graffiti, even in several coats, it can be removed using specific products for removing paint from plastic materials, which do not harm the original appearance of the surface. These products are available commercially in the form of gel, liquid or spray. Most of these can also be used to remove stubborn dirt such as grease, algae, etc. Follow the product supplier's instructions and after treatment never forget to rinse the surface thoroughly with water. We suggest the use of the graffiti remover; we advise to contact the local Abet Laminati representative for further information.
- In case of use of any cleaner, we recommend to test it over a small hidden area of the panel first in order to evaluate the result and to be sure the product is suitable for MEG.

9. Disclaimer

IMPORTANT:

- The advice and guidelines contained in this MEG Technical Manual are based upon current knowledge of the properties of MEG material, and the processing techniques are based upon experience, and the materials physical attributes, this information may be updated or amended at any time without prior notice, and it is the responsibility of the user to ensure that they have the most up-to-date version.
- Since Abet Laminati does not undertake either the processing nor installation of MEG Panels, Abet Laminati can in no event be deemed to be responsible for any defects or loss resulting from aforesaid processes, nor for any accidental injury, whether minor, permanent disability or death arising from the operations of processing or installation. Therefore the advice and guidelines given in this Manual are provided, subject to the protection of all rights in respect of Abet Laminati.
- During the installation of MEG, should the fitter/installer have any questions relating to the installing methods which are not covered in this manual, then the fitter/installer must contact the local Abet Laminati representative for clarification and additional advice, failure to do so exempts Abet Laminati of responsibility or resulting losses.
- National and local building guidelines, obligations and legislations and more specifically the application guidelines provided by national institutions predominate the guidelines described in this technical manual and they are assumed to be known by the client, architect, contractor and its subcontractor if any. These guidelines and any legislation should be respected and applied by way of priority. If there is a conflict between local or National Building Regulations, legislature, and the advice and guidelines given in this manual, then it is understood that the client, architect, contractor and any sub-contractor must contact the local Abet Laminati representative for advice.

January 2016

ABET LAMINATI 
Unlimited selection

MEG
MATERIAL EXTERIOR GRADE
BUILDING
FAÇADES