

MONTERINGSANVISNING

Benkeplate Level – Produktgruppe 7055

1 Leverandør

Fritzøe Engros AS
Postboks 2055

Telefon: + 47 33 13 64 00

E-post: teknisk@fritzoengros.no

Web: www.fritzoengros.no

2 Produktnavn

Benkeplate Level.

3 Produktbeskrivelse

Level laminat benkeplater er produsert med kjerne av sponplate og overflate i høytrykkslaminat (HPL) i mange forskjellige dekor. HPL er fremstilt fra ubleket kraftpapir, dekorpapir, fenolharts og melaminharts. Papirene presses sammen under høyt trykk og varme. Overflaten på platene er vanntette og meget slitesterk. Undersiden er belagt med en beskyttende sperre som hindrer fukt fra oppvaskmaskiner etc. Platene kan leveres med postform (avrundet kant) på en langside eller skarpkant, med eller uten kantlist.

Benkeplatene er laget spesielt med tanke på kjøkkeninnredning, men egner seg også godt til annen innredning.

4 Dimensjoner

- Standard platetykkelser 28 MM.
- Standard plateformater bredde 635 mm, og lengder 1870 mm. 3020 mm og 4100 mm.

5 Lagring og klimatisering

Kontroll: Benkeplatene skal kontrolleres for eventuelle synlige feil før montering. Reklamasjoner skal med en gang meldes til forhandler før montering. Les hele monteringsanvisningen før monteringen starter.

Produktinfo: Benkeplatene består av sponplate som kjern, overflaten har høytrykkslaminat og undersiden er belagt med en sperrefolie. Det er viktig at benkeplatene klimatiseres og balanseres med den relative fuktigheten som platene skal være i før montering.

Oppbevaring: Før montering skal benkeplaten oppbevares innendørs i min. 3 døgn i ca. 20gr, og i en relativ luftfuktighet på 40-60%. Platen skal ligge vannrett på et plant underlag og innpakket i emballasje helt til montering finner sted. Beskytt platen mot direkte strålevarme og sollys.

6 Montering

Følg monteringsanvisningen på de neste sidene.

7 HMS

Det er ikke behov for spesielle forebyggende tiltak ved håndtering eller bearbeiding av platene. Det anbefales bruk av personlig verneutstyr, som støvmaske, hørselvern og vernebriller, når platene bearbeides.

MONTERINGSANVISNING

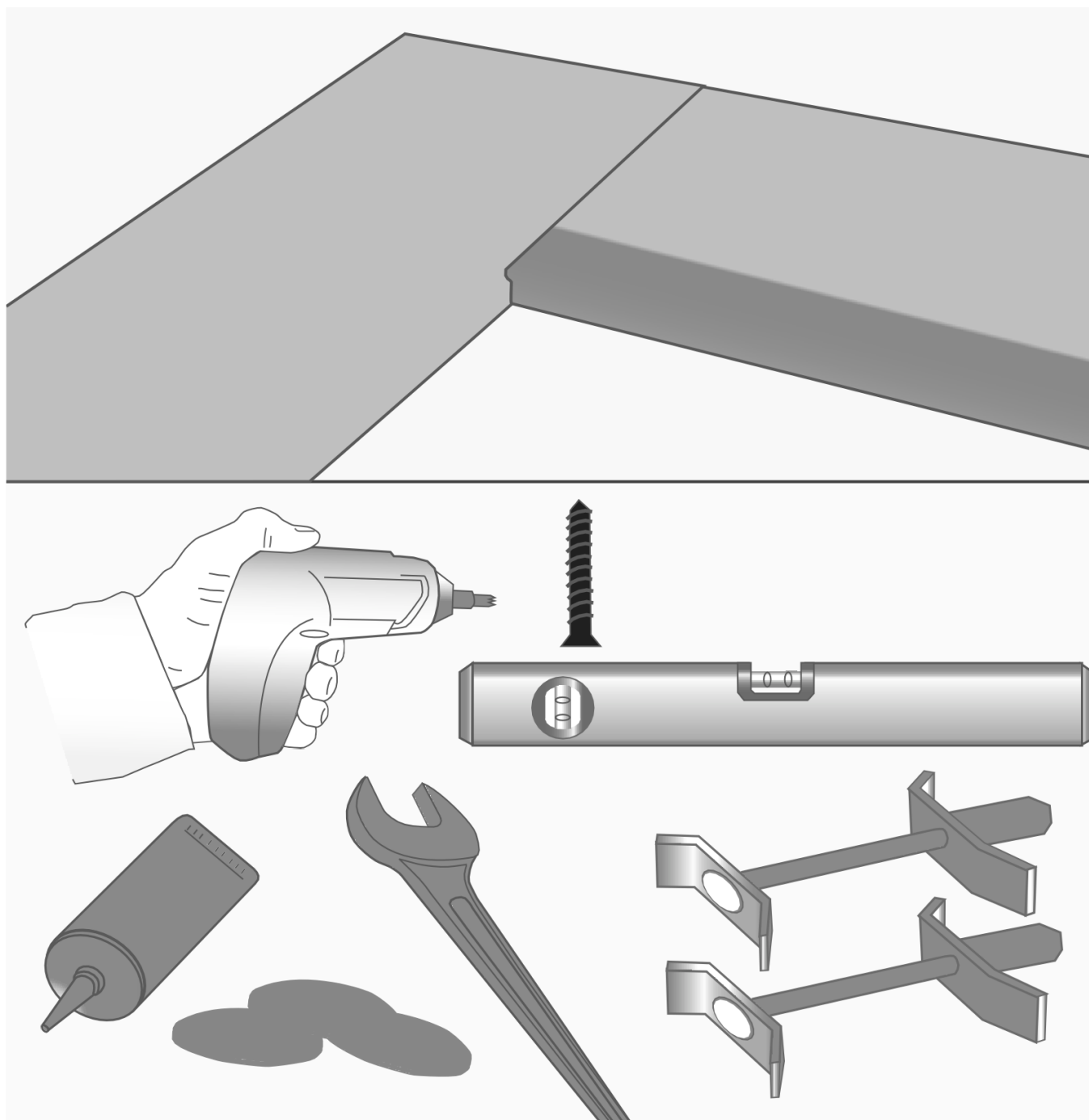

MONTERINGSANVISNING

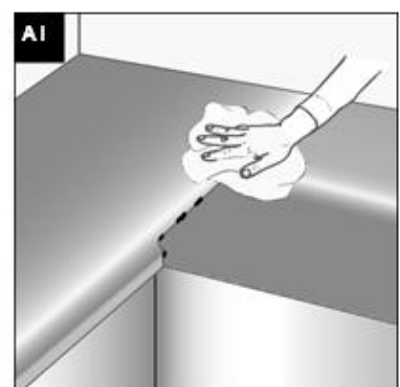
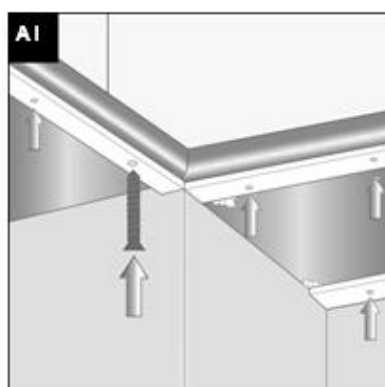
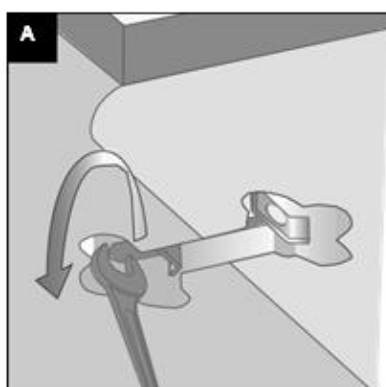
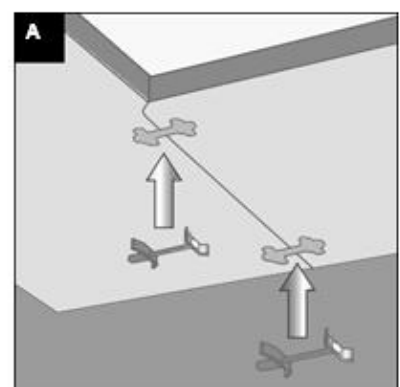
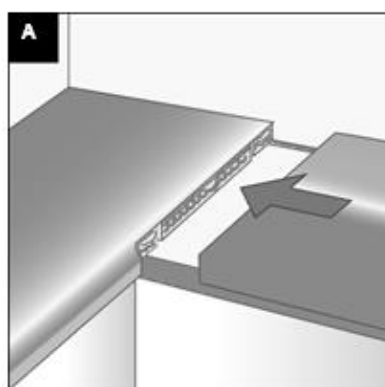
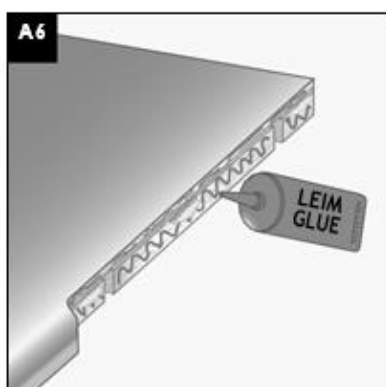
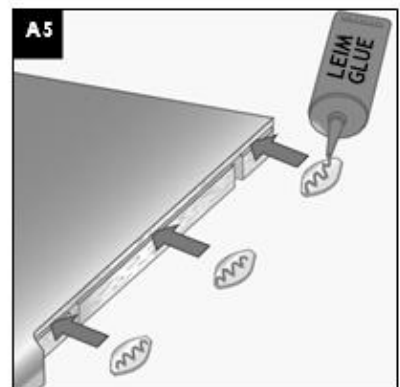
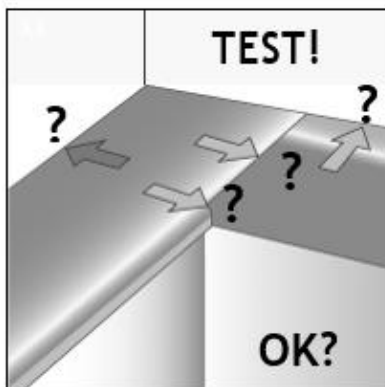
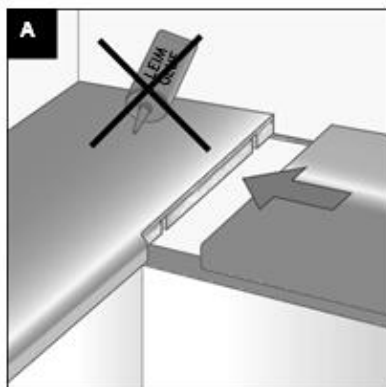
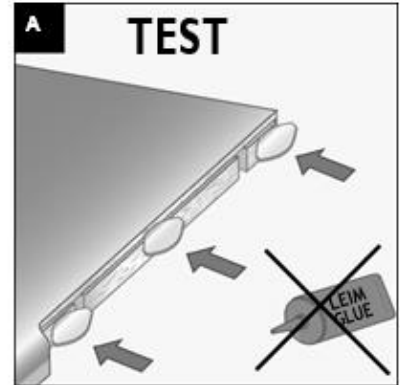
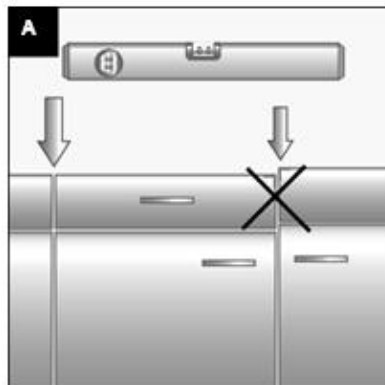
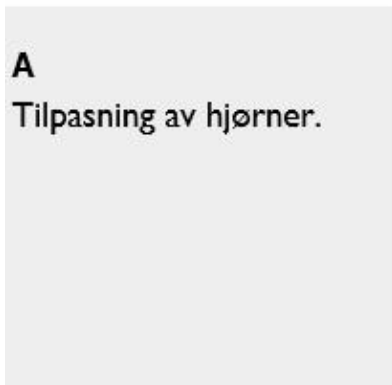

MONTERINGSANVISNING

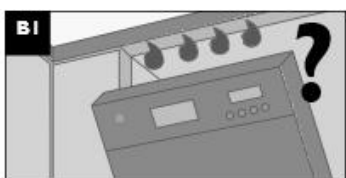
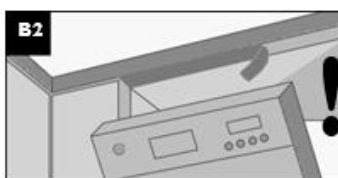
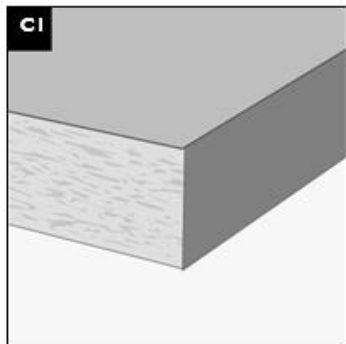
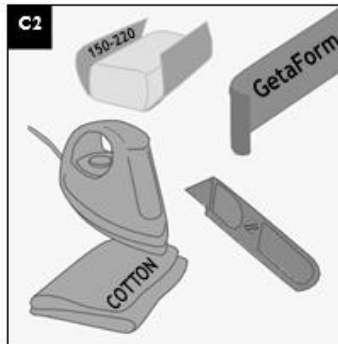
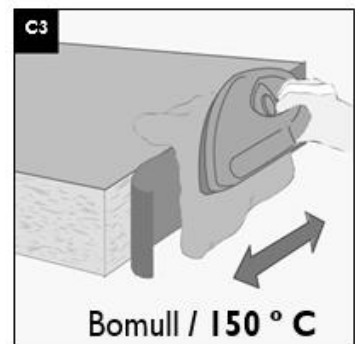
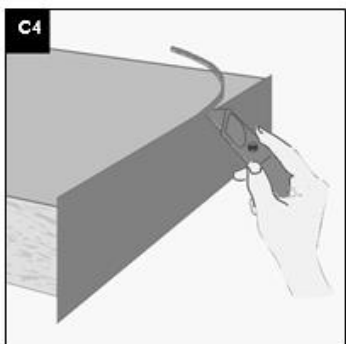
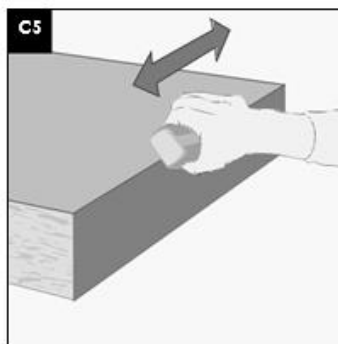
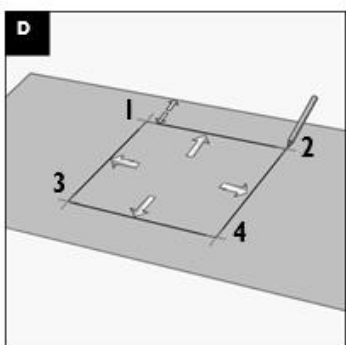
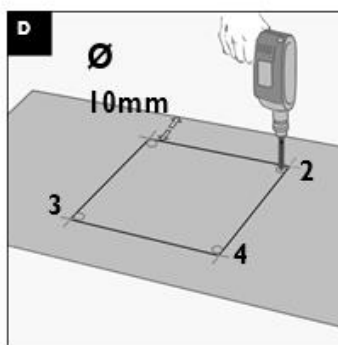
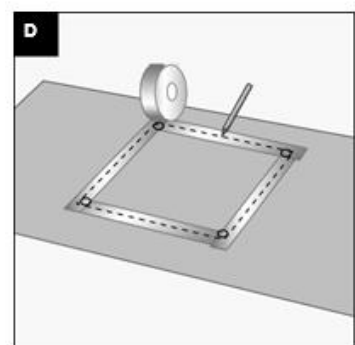
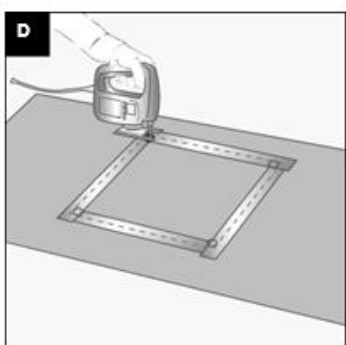
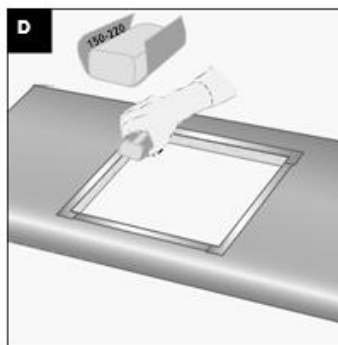
<p>B Aluminiumstape</p>	<p>B1</p> 	<p>B2</p> 
<p>C Kantlister.</p>	<p>C1</p> 	<p>C2</p> 
<p>C3</p>  <p>Bomull / 150 ° C</p>	<p>C4</p> 	<p>C5</p> 
<p>D Utskjering for vask.</p>	<p>D</p> 	<p>D</p>  <p>Ø 10mm</p>
<p>D</p> 	<p>D</p> 	<p>D</p> 

MONTERINGSANVISNING

